

# 2 Diodes and Transistors

## Student Group

First Name	Surname	Matrikel Nr.

## Table of Contents

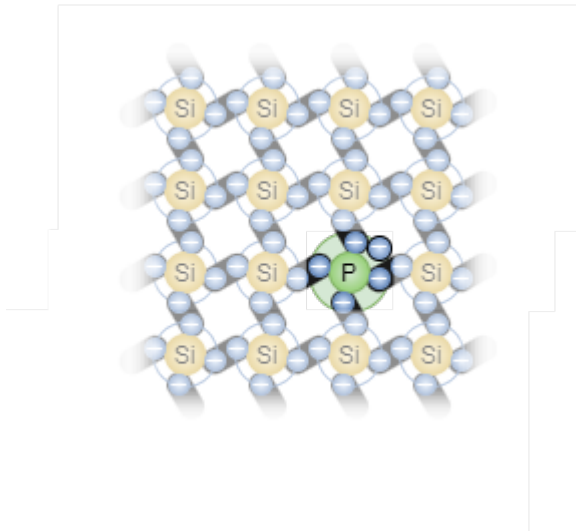
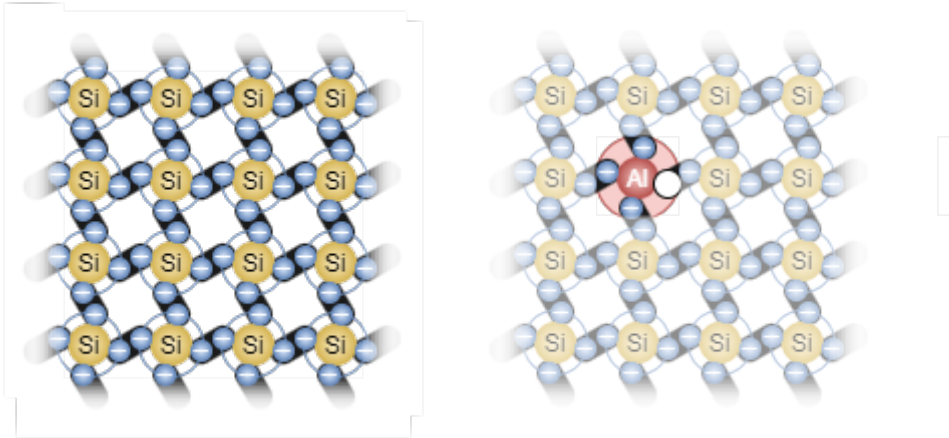

Bohr atomic model

1a

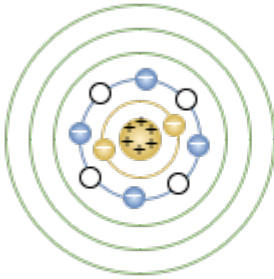

1b

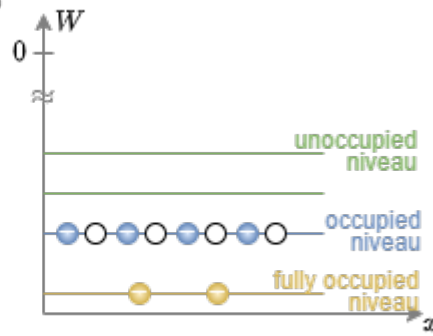

2a

Band model

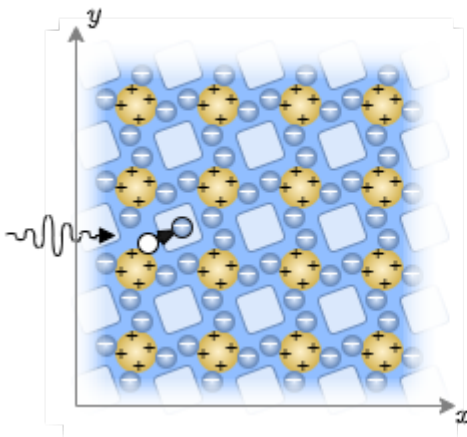

2b

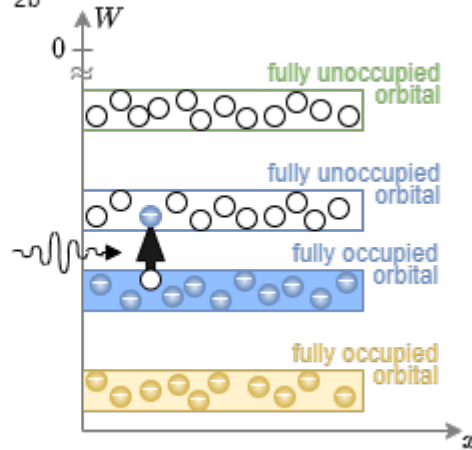

	a)	b)	c)	d)
1. Intrinsic				
2. n-Doped				
3. p-Doped				

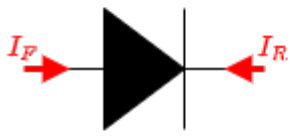

IEEE

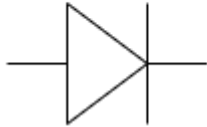

DIN/EN

p-Doped

n-Doped

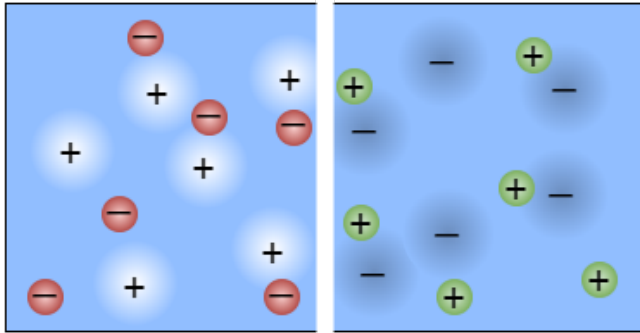

Recombination

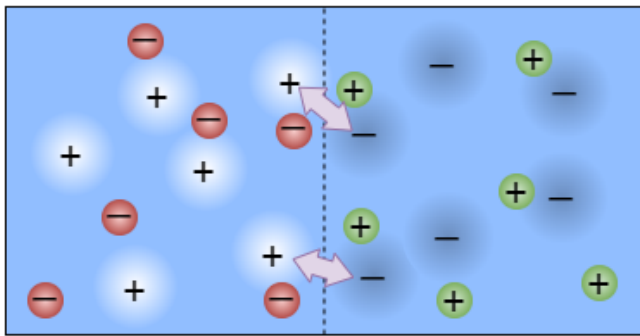

Depletion Region

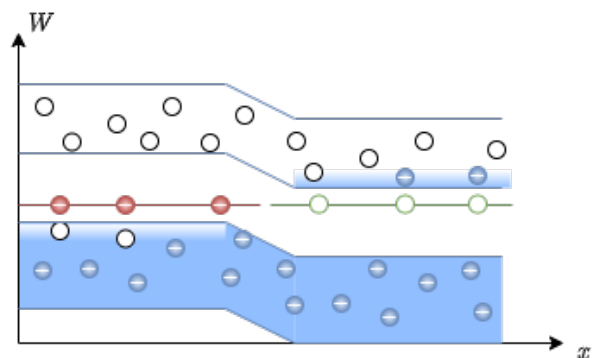
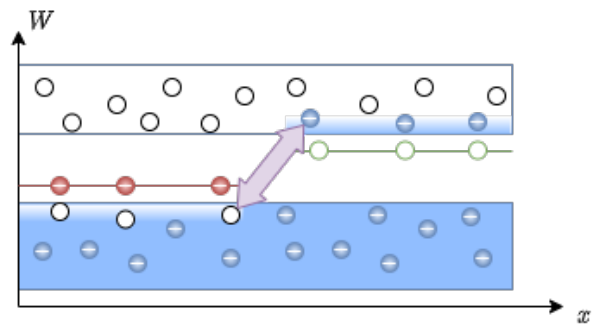
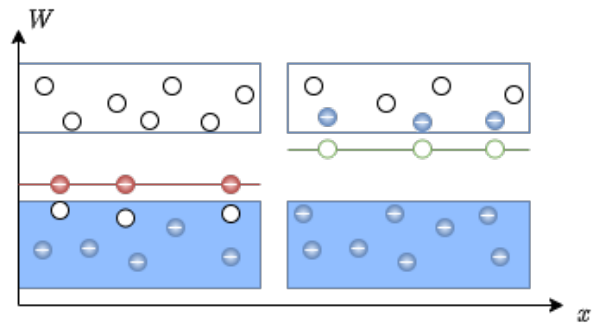
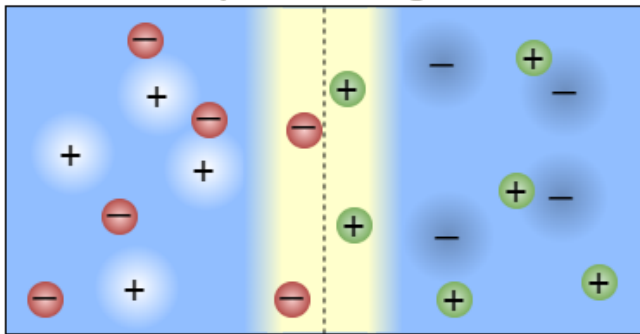

### without external Voltage

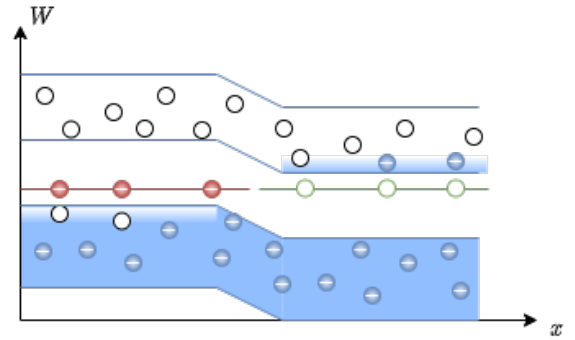
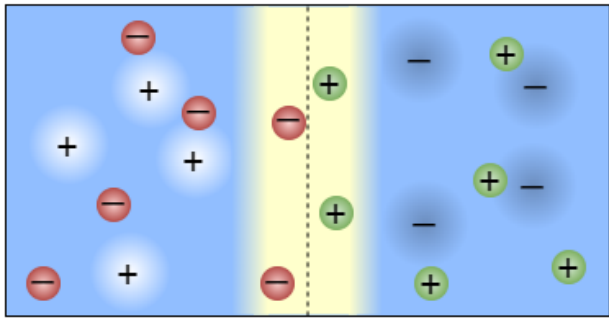

### with $U_F > 0$

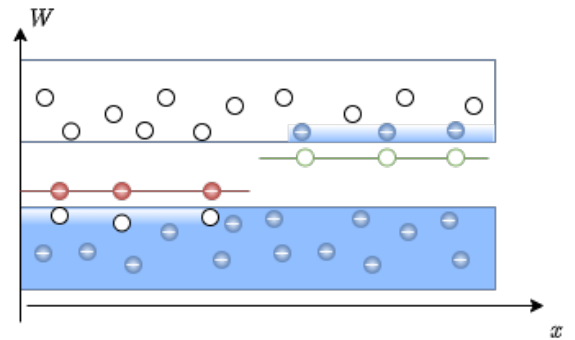
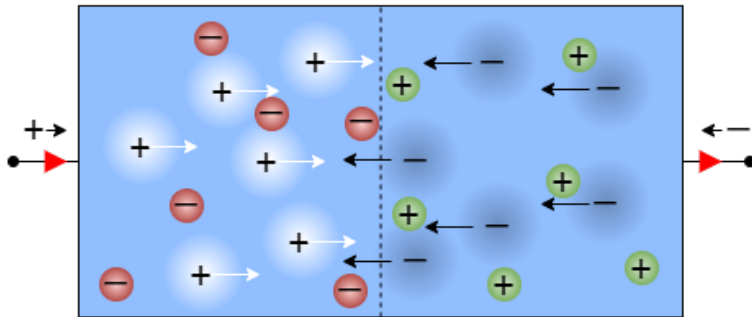

### pn Junction with steep Doping

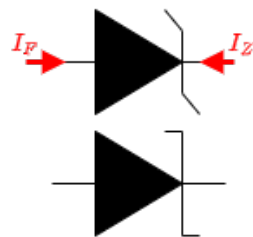
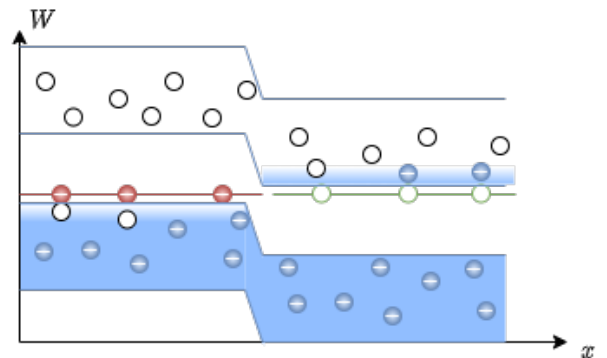
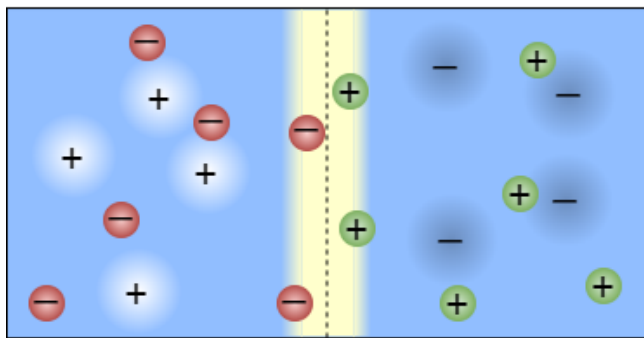

IEEE

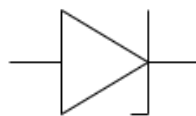

DIN/EN

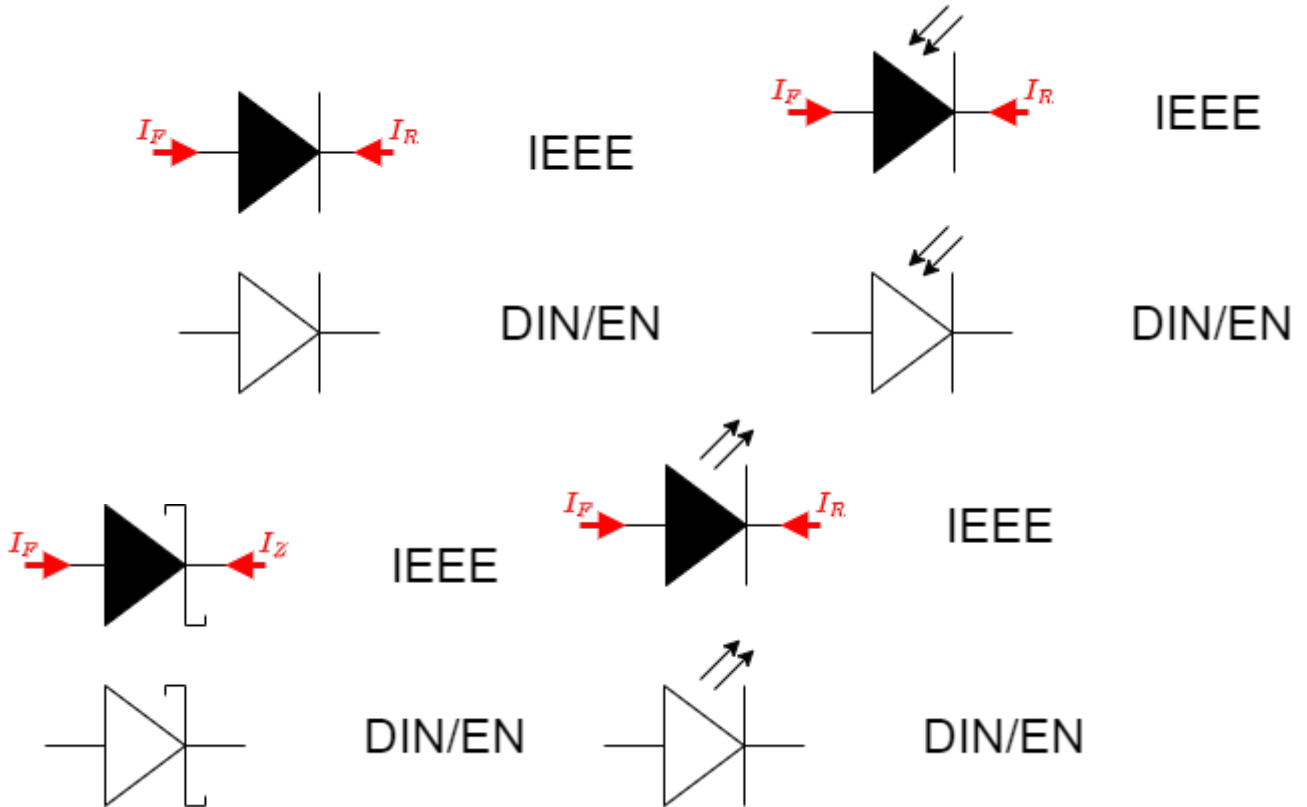
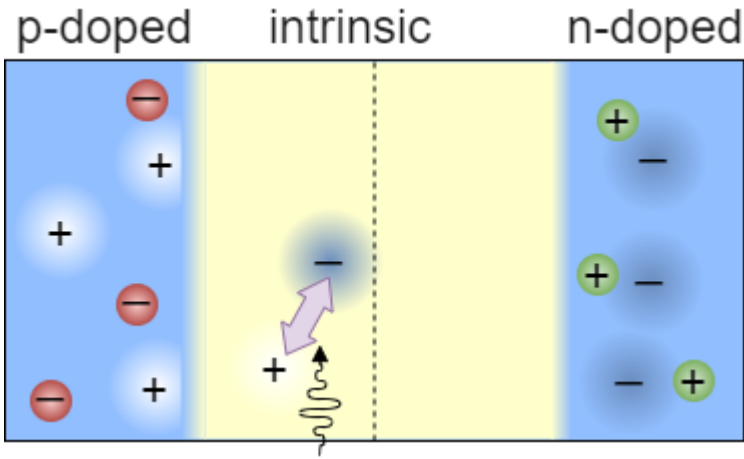

From:  
<https://wiki.mexle.org/> - MEXLE Wiki

Permanent link:  
[https://wiki.mexle.org/circuit\\_design/2\\_diodes?rev=1636850474](https://wiki.mexle.org/circuit_design/2_diodes?rev=1636850474)

Last update: 2021/11/14 01:41

