

aufgabe_2.7.7_mit_rechnung

Student Group

First Name	Surname	Matrikel Nr.

Table of Contents

Task 2.7.7 Simplifying Circuits (exam task, about 8% of a 60-minute exam, WS2020)	2
---	---

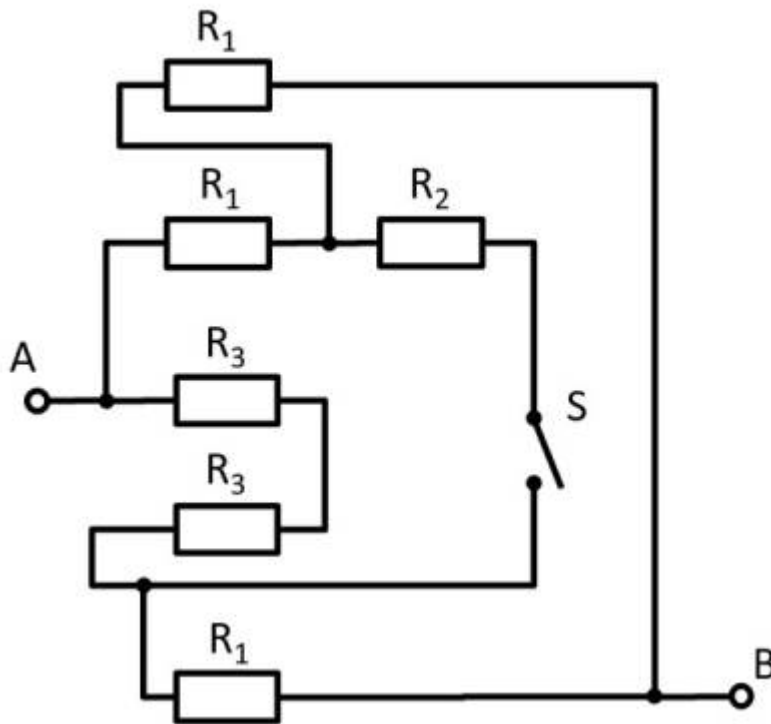
Task 2.7.7 Simplifying Circuits (exam task, about 8% of a 60-minute exam, WS2020)

Given is the adjoining circuit with

$$R_1 = 10 \Omega$$

$$R_2 = 20 \Omega$$

$$R_3 = 5 \Omega$$

and the switch S .

1. determine the total resistance R_{ges} between A and B by summing the resistances with the switch S open.

Tips for solving

- How can the circuit be better represented or pulled apart?
- The switch should be replaced by an open wire in this case.

Solution path

First of all, it is a good idea to reshape the circuit so that the actual structure becomes visible. For this purpose, the individual branches can be highlighted in color and interpreted as a “conductive rubber band”.

This results in:



Thus R_3 and R_3 can be combined to $R_{33} = 2 \cdot R_3 = R_1$, yielding a left and a right voltage divider.

Now it is visible that in the left and right voltage divider the same potential is at the respective branch, or at the node K1 (green) and K2 (pink).

Thus, the total resistance can be calculated as $R_{ges} = (2 \cdot R_1) || (2 \cdot R_1)$. However, by symmetry, nodes K1 and K2 can also be short-circuited. Thus, $R_{ges} = 2 \cdot (R_1 || R_1)$ also holds.

Final result

$$\begin{aligned} R_{ges} &= 2 \cdot (10 \Omega || 10 \Omega) = 10 \Omega \end{aligned}$$

2. what is the total resistance when switch S is closed?

Final result

Due to symmetry, the potentials at K1 and K2 are equal. Thus, no current flows across resistor R_2 even when the switch is closed. So the resistance remains the same.

From: <https://wiki.mexle.org/> - MEXLE Wiki

Permanent link: https://wiki.mexle.org/electrical_engineering_1/aufgabe_2.7.7_mit_rechnung?rev=1633091506

Last update: 2021/10/01 14:31

