

5 DC Circuit Transients (on RC elements)

Student Group

First Name	Surname	Matrikel Nr.

Table of Contents

5 DC Circuit Transients (on RC elements)	2
5.1 Time Course of the Charging and Discharging Process	5
Learning Objectives	5
Charging a capacitor at time $t=0$	7
Notice:	9
Discharging a capacitor at time $t=0$	10
Periodic switching operations	12
5.2 Energy stored in a Capacitor	13
Learning Objectives	13
Energy consideration of the capacitor	14
Energy Consideration on the Resistor	14
Consideration of total energy turnover	15
Exercises	16
Exercise 5.2.1 Capacitor charging/discharging practice Exercise	16
Exercise E Exercise 5.2.2 Capacitor charging/discharging	16
Exercise E5.2.2 Charge balance of two capacitors (educational exercise, not part of an exam)	18
Exercise 5.2.3: Charging and Discharging of RC elements (exam task, ca. 11 % of a 60- minute exam, WS2020)	19

5 DC Circuit Transients (on RC elements)

1. Capacitor in ICs --> MOSFET
2. Charge/discharge FET capacitor.

Fig. 1: Capacitor in electrical circuit



Here we will shortly introduce the basic idea behind a capacitor. A more detailed analysis will follow in electrical engineering II.

A capacitor consists of two insulated conductors (electrodes) separated by an insulator (cf. [figure 1](#)).

The electrodes serve as “charge carrier storage”. This is done in the following manner:

1. An external source draws charge carriers from one of the electrodes and carries them to the other electrode.
2. If the external source is a voltage source with the voltage U , a stationary state is reached after a certain time.
In this state there is a fixed number of $+Q$ on the positive electrode and $-Q$ on the negative electrode.
3. These charges form an electric field in the space between the electrodes. This field stores the supplied energy.

As larger the voltage U , more charges Q are stored on the electrode. This relationship is directly proportional to the proportionality constant C :

$$\begin{aligned} C &= \frac{Q}{U} \quad \text{with:} \quad [C] = 1 \sim \frac{\text{As}}{\text{V}} = 1 \\ &\sim \text{Farad} \end{aligned}$$

But it is not always directly recognizable that a structure contains a capacitor. So the following examples are also capacitors:

- **open switch:** If there is a voltage between the two metal parts, charges can also accumulate there. Since the distances are usually large and the air is used as the dielectric, the capacitance of the capacitor formed in this way is very small.
- **Overhead line:** An overhead line also represents a capacitor against the ground potential of the earth. The charging and discharging by the alternating current leads to the fact that polarizable molecules can align themselves. For example, the water drops near the line are rolled through the field and hum with $100\sim\text{Hz}$ and many times that (harmonics). Peak discharge results in a high-frequency crackle.
- **Conductor trace:** A trace on a PCB can also be a capacitor against a nearby ground plane. This can be a problem for digital signals (see the charge and discharge curves below).
- **Human body:** The human body can likewise pick up charge. The charge thus absorbed forms a capacitor with respect to other objects. This can be charged up to some kV . This is a particular problem in electrical laboratories, as the mere touching of components can destroy them.
- **Membrane of nerve cells:** Nerve cells also result in a capacitor due to the lipid bilayer (membrane of the nerve cell) and the two cellular fluids with different electrolytes (ions). The nerve cells are surrounded by a thick layer (myelin layer) for faster transmission. This lowers the capacitance and thus increases the successive charging of successive parts of the nerve cell. In diseases such as Creutzfeldt-Jakob or multiple sclerosis, this layer thins out. This leads to the delayed signal transmission which characterizes the disease patterns.

Fig. 2: Circuit for viewing charge and discharge curve

\$... \$...

In the following, the charging process of a capacitor is to be considered in more detail. For this purpose, one has to realize, that during the charging of the capacitor, besides the voltage source U_{s} and the capacitor C , there is always a resistance R in the circuit. This is composed of the internal resistance of the (non-ideal) voltage source, the internal resistance of the capacitor, and the parasitic (=interfering) resistance of the line. In practical applications, it is often desired that capacitors charge in a certain time range. For this purpose, another real resistor is inserted into the circuit. The resulting series of resistors and capacitors is called an **RC element**. It resembles a voltage divider in which a resistor has been replaced by a capacitor.

To start the charging, an (ideal) switch S is inserted. The circuit to be considered then looks like shown in [figure 2](#).

An ideal switch is characterized by:

- infinitely fast switching
- resistance of $0 \sim \Omega$ in the closed state ("short circuit")
- resistance $\rightarrow \infty$ in the open state ("open line")
- no capacitive effect

In this chapter also time-varying quantities are considered. These are generally marked with lowercase letters. Examples of time-varying quantities are:

- A **time-varying voltage $u_C(t)$ across a capacitor** or the **voltage U_{rms} of an ac voltage source** as opposed to a constant voltage U_{rms} across a constant voltage source.
- A **time-varying current $i_L(t)$ across a coil** or **time-varying current $i_C(t)$ across a capacitor**.

Since the time dependence is already clear from the lowercase letter, these quantities are occasionally not indicated by the trailing (t) . So it is $u = u(t)$.

5.1 Time Course of the Charging and Discharging Process

Learning Objectives

By the end of this section, you will be able to:

1. know the time constant τ and in particular calculate it.
2. determine the time characteristic of the currents and voltages at the RC element for a given resistance and capacitance.
3. know the continuity conditions of electrical quantities.
4. know when (=according to which measure) the capacitor is considered to be fully charged/discharged, i.e. a steady state can be considered to have been reached.

In the simulation below you can see the circuit mentioned above in a slightly modified form:

- The capacitance C can be charged via the resistor R if the toggle switch S connects the DC voltage source U_{rms} to the two.
- But it is also possible to short-circuit the series circuit of R and C via the switch S .
- Furthermore, the current i_C and the voltage u_C are displayed in the oscilloscope as data points over time and in the circuit as numerical values.
- Additionally it is possible to change the capacitance value C and resistance value R with the sliders Capacitance C and Resistance R .

Exercises:

1. Become familiar with how the capacitor current i_C and capacitor voltage u_C depend on the given capacitance C and resistance R .
To do this, use for $R = \{ 10 \sim \Omega, 100 \sim \Omega, 1 \sim k\Omega \}$ and $C = \{ 1 \sim \text{nmF}, 10 \sim \mu\text{F} \}$. How fast does the capacitor voltage u_C increase in each case n ?
2. Which quantity (i_C or u_C) is continuous here? Why must this one be continuous? Why must the other quantity be discontinuous?

In the following, this circuit is divided into two separate circuits, which consider only charging and only discharging.

Here is a short introduction about the transient behavior of an RC element (starting at 15:07 until 24:55)



To understand the charging process of a capacitor, an initially uncharged capacitor with capacitance C is to be charged by a DC voltage source U_{rms} via a resistor R .

- In order that the voltage U_{rms} acts at a certain time $t_0 = 0 \text{ s}$ the switch S is closed at this time.
- Directly after the time t_0 the maximum current (“charging current”) flows in the circuit. This is only limited by the resistor R . The uncharged capacitor has a voltage $u_C(t_0) = 0 \text{ V}$ at that time. The maximum voltage $u_R(t_0) = U_{\text{rms}}$ is applied to the resistor. The current is $i_C(t_0) = \frac{U_{\text{rms}}}{R}$.
- The current causes charge carriers to flow from one electrode to the other. Thus the capacitor is charged and its voltage increases u_C .
- Thus the voltage u_R across the resistor is reduced and so is the current i_R .
- With the current thus reduced, less charge flows on the capacitor.
- Ideally, the capacitor is not fully charged to the specified voltage U_{rms} until $t \rightarrow \infty$. It then carries the charge: $q(t \rightarrow \infty) = Q = C \cdot U_{\text{rms}}$

Fig. 2: circuit for viewing the charge curve



The process is now to be summarized in detail in formulas. Linear components are used in the circuit, i.e. the component values for the resistor R and the capacitance C are independent of the current or the voltage. Then definition equations for the resistor R and the capacitance C are also valid for time-varying or infinitesimal quantities:

$$\begin{aligned} R &= \frac{u_R(t)}{i_R(t)} = \frac{\mathrm{d}u_R}{\mathrm{d}i_R} = \text{const.} \quad C \\ &= \frac{q(t)}{u_C(t)} = \frac{\mathrm{d}q}{\mathrm{d}u_C} = \text{const.} \quad \tag{5.1.1} \end{aligned}$$

The following explanations are also well explained in these two videos on [charging](#) and [discharging](#).

Charging a capacitor at time $t=0$

By considering the loop, the general result is: the voltage of the source is equal to the sum of the two voltages across the resistor and capacitor.

$$U_{\text{s}} = u_R + u_C = R \cdot i_C + u_C \quad \tag{5.1.2}$$

At the first instant $\mathrm{d}t$, an infinitesimally small charge “chunk” $\mathrm{d}q$ flows through the circuit driven by the current i_C from the voltage source. For this, (5.1.1) gives:

$$i_C = \frac{\mathrm{d}q}{\mathrm{d}t} \quad \text{and} \quad \mathrm{d}q = C \cdot \mathrm{d}u_C$$

The charging current i_C can be determined from the two formulas:

$$i_C = C \cdot \frac{\mathrm{d}u_C}{\mathrm{d}t} \quad \tag{5.1.3}$$

Thus (5.1.2) becomes:

$$U_{\text{R}} = u_{\text{R}} + u_{\text{C}} \quad \&= R \cdot C \cdot \frac{d u_{\text{C}}}{dt} + u_{\text{C}}$$

here follows some mathematics:

This result represents a 1st order differential equation. This should generally be rewritten so that the part that depends (on the variable) is on one side and the rest is on the other. This is already present here. The appropriate approach to such a problem is:

$$u_{\text{C}}(t) = \mathcal{A} \cdot e^{\mathcal{B} \cdot t} + \mathcal{C}$$

$$U_{\text{R}} = R \cdot C \cdot \frac{d}{dt} (\mathcal{A} \cdot e^{\mathcal{B} \cdot t} + \mathcal{C}) + \mathcal{A} \cdot e^{\mathcal{B} \cdot t} + \mathcal{C} \\ \&= R \cdot C \cdot \mathcal{A} \mathcal{B} \cdot e^{\mathcal{B} \cdot t} + \mathcal{A} \cdot e^{\mathcal{B} \cdot t} + \mathcal{C} \\ \&= (R \cdot C \cdot \mathcal{A} \mathcal{B} + \mathcal{A}) \cdot e^{\mathcal{B} \cdot t} + \mathcal{C}$$

This equation must hold for every t . This is only possible if the left, as well as the right term, become equal to 0.

Thus:

$$\mathcal{C} = U_{\text{R}} \quad \& \quad R \cdot C \cdot \mathcal{A} \mathcal{B} + \mathcal{A} = 0 \\ \quad \quad \quad | : \mathcal{A} \quad | -1 \quad | R \cdot C \cdot \mathcal{B} = -1 \quad | \mathcal{B} = -\frac{1}{RC}$$

So it follows:

$$u_{\text{C}}(t) = \mathcal{A} \cdot e^{-\frac{t}{RC}} + U_{\text{R}}$$

For the solution it must still hold that at time $t_0=0$ $u_{\text{C}}(t_0) = 0$ just holds:

$$0 = \mathcal{A} \cdot e^{\text{large}\{0\}} + U_{\text{R}} \quad \& \quad 0 = \mathcal{A} + U_{\text{R}} \\ \quad \quad \quad | \mathcal{A} = -U_{\text{R}}$$

So the solution is:

$$u_{\text{C}}(t) = -U_{\text{R}} \cdot e^{-\frac{t}{RC}} + U_{\text{R}}$$

And this results in: $u_{\text{C}}(t) = U_{\text{R}} \cdot (1 - e^{-\frac{t}{RC}})$

And with (5.1.3), $i_{\text{C}}(t)$ becomes: $i_{\text{C}}(t) = \frac{U_{\text{R}}}{R} \cdot e^{-\frac{t}{RC}}$

In [figure 4](#), the two time course diagrams for the charging voltage $u_{\text{C}}(t)$ and the charging current $i_{\text{C}}(t)$ of the capacitor are shown.

Fig. 4: charging curve



Notice:

- There must be a unitless term in the exponent. So RC must also represent a time. This time is called **time constant** $\tau = R \cdot C$.
- At time $t = \tau$, we get: $u_C(t) = U_{\text{rms}} \cdot (1 - e^{-1}) = U_{\text{rms}} \cdot (1 - \frac{1}{e}) = U_{\text{rms}} \cdot (\frac{e-1}{e}) = 0.63 \cdot U_{\text{rms}} = 63\% \cdot U_{\text{rms}}$.
So, **the capacitor is charged to 63% after one τ .**
- At time $t = 2 \cdot \tau$ we get: $u_C(t) = U_{\text{rms}} \cdot (1 - e^{-2}) = 86\% \cdot U_{\text{rms}} = (63\% + (100\% - 63\%) \cdot 63\%) \cdot U_{\text{rms}}$. So, **after each additional τ , the uncharged remainder (1-63%) is recharged to 63%.**
- After about $t = 5 \cdot \tau$, the result is a capacitor charged to over 99%. In real circuits, **a charged capacitor can be assumed after $5 \cdot \tau$.**
- The time constant τ can be determined graphically in several ways:
 - Plotting the voltage value corresponding to 63% on the y-axis. Finding the point of intersection with the graph. Reading the time (see green lines in figure 4).
 - Plotting the tangent to the (voltage) charge curve at the time of the discharged capacitor. This intersects a horizontal line at the level of the charging voltage at the point $t = \tau$ (see black and light blue lines in figure 4).

Discharging a capacitor at time $t=0$

Fig. 5: circuit for viewing discharge curve

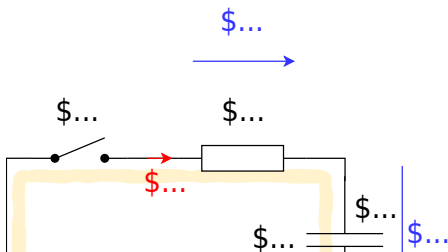

The following situation is considered for the discharge:

- A capacitor charged to voltage U_{rms} with capacitance C is short-circuited across a resistor R at time $t=t_0$.
- As a result, the full voltage U_{rms} is initially applied to the resistor: $u_R(t_0)=U_{\text{rms}}$
- The initial discharge current is thus defined by the resistance: $i_C = \frac{u_R}{R}$
- The discharging charges lower the voltage of the capacitor u_C , since: $u_C = \frac{q(t)}{C}$
- Ideally, the capacitor is not fully discharged before $t \rightarrow \infty$.

Also, this process now is to put into a formula in detail. By looking at the loop, the general result is: the sum of the two voltages across the resistor and capacitor adds up to zero.

$$\begin{aligned} 0 &= u_R + u_C = R \cdot i_C + u_C \end{aligned}$$

This gives (5.1.3):

$$\begin{aligned} 0 &= u_R + u_C = R \cdot C \cdot \frac{du_C}{dt} + u_C \end{aligned}$$

also here uses some mathematics:

This result again represents a 1st order differential equation. The appropriate approach to such a problem is:

$$\begin{aligned} u_C(t) &= \mathcal{A} \cdot e^{\mathcal{B} \cdot t} + \mathcal{C} \end{aligned}$$

\end{align*}

$$0 = R \frac{d}{dt} (A e^{Bt} + C) + A e^{Bt} + C \\ = R \frac{d}{dt} (A e^{Bt} + C) + A e^{Bt} + C - C = (R \frac{d}{dt} (A e^{Bt} + C) + A e^{Bt})$$

This equation must hold for every t . This is only possible if the left, as well as the right term, become equal to 0. Thus:

$$C = 0 \quad R \frac{d}{dt} (A e^{Bt} + C) + A e^{Bt} = 0 \\ \Rightarrow A = -\frac{1}{RC} \quad B = -\frac{1}{RC}$$

So it follows:

$$u_C(t) = A e^{-\frac{t}{RC}} + 0$$

For the solution it must still hold that at time $t_0=0$ $u_C(t_0) = U_{\text{rms}}$ just holds:

$$U_{\text{rms}} = A e^{-\frac{0}{RC}} = A$$

Therefore, the result is:

$$u_C(t) = U_{\text{rms}} e^{-\frac{t}{RC}}$$

Fig. 6: discharge curve



And this results in:
$$u_C(t) = U_{\text{rms}} \cdot e^{-\frac{t}{\tau}}$$

$$\tau = RC$$

And with (5.1.3), i_C becomes:
$$i_C(t) = -\frac{U_{\text{rms}}}{R} \cdot e^{-\frac{t}{RC}}$$

In figure 6 the two time course diagrams are again shown; now for the discharge voltage $u_C(t)$ and the discharge current $i_C(t)$ of the capacitor. Since the current now flows out of the capacitor, the sign of i_C is negative.

Periodic switching operations

In the simulation on the right, a periodic switching operation can be seen. The capacitor is periodically charged and discharged via the switch. Three sliders are given in the simulation to change the resistance R (Resistance R), the capacity C (Capacity C), and the frequency f (Frequency f). In the simulation below, the voltage u_C across the capacitor is shown in green and the current i_C is shown in yellow.

Exercises:

1. Increase the the frequency to $f=10 \sim \{\text{rm kHz}\}$ using the appropriate slider. What is the change for u_C and i_C ?
2. Now increase the capacitance to $C=10 \sim \{\text{rm }\mu\text{F}\}$ using the corresponding slider. What is the

change for u_C and i_C ?

- Now increase the resistance to $R = 1 \text{ k}\Omega$ using the corresponding slider. What is the change for u_C and i_C ?

5.2 Energy stored in a Capacitor

Learning Objectives

By the end of this section, you will be able to:

- calculate the energy content in a capacitor.
- calculate the change in energy of a capacitor resulting from a change in voltage between the capacitor terminals.
- calculate (initial) current, (final) voltage, and charge when balancing the charge of several capacitors (also via resistors).

Fig. 2: circuit for viewing the charge curve

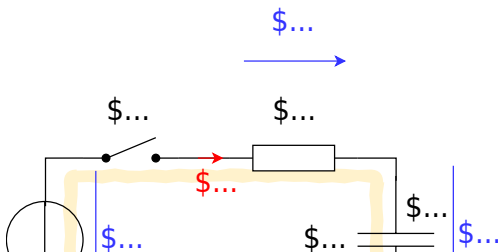

Now the capacitor as energy storage is to be looked at more closely. This derivation is also explained in [this youtube video](#). For this, we consider again the circuit in [figure 2](#) an. According to the chapter [Preparation, Properties, and Proportions](#), the power for constant values (DC) is defined as:

$$\begin{aligned} P &= \frac{\Delta W}{\Delta t} = U \cdot I \end{aligned}$$

For variable signals, the instantaneous power is given as:

$$\begin{aligned} p &= \frac{d w}{d t} = u \cdot i \end{aligned}$$

Energy consideration of the capacitor

Charging the capacitor at time $t_0 = 0$ results in $\Delta W = W_C$ for the stored energy at a later time $t_1 = t$:

$$\begin{aligned} \Delta W_C &= \int_{t_0}^{t_1} \frac{d w}{d t} = \int_0^t u \cdot i \cdot dt = \\ &= \int_0^t u_C \cdot i_C \cdot dt \end{aligned} \tag{5.2.1}$$

$$\begin{aligned} \text{During the charging process } u_C(t) &= U_s \cdot (1 - e^{-\frac{t}{\tau}}) \\ i_C(t) &= \frac{U_s}{R} \cdot e^{-\frac{t}{\tau}} \end{aligned} \tag{5.2.2}$$

In particular:

$$\begin{aligned} C &= \frac{q(t)}{u_C(t)} \quad \& \rightarrow \quad \& q(t) \&= u_C(t) \cdot C \\ i_C(t) &= \frac{dq(t)}{dt} \quad \& \rightarrow \quad \& C = \text{const.} \quad \& i_C(t) \&= C \\ & \cdot \frac{du_C(t)}{dt} \end{aligned}$$

Thus, the stored energy from formula (5.2.1):

$$\begin{aligned} \Delta W_C &= \int_0^t u_C(t) \cdot C \cdot \frac{du_C(t)}{dt} \\ dt & \quad \& | \text{substitution of integration variable: } t \rightarrow u_C \quad \&= \\ \int_{U_0}^{U_1} u_C(t) \cdot C \cdot du_C & \quad \& | \text{Since the capacity is constant, it} \\ \text{can be written ahead of the integral} & \quad \&= C \cdot \int_{U_0}^{U_1} u_C \cdot du_C \\ \left[\frac{1}{2} u_C^2 \right]_{U_0}^{U_1} & \quad \& \end{aligned} \quad \begin{aligned} \Delta W_C &= \\ \frac{1}{2} C & \cdot (U_1^2 - U_0^2) \end{aligned} \tag{5.2.3}$$

Thus, for a fully discharged capacitor ($U_s = 0 \sim V$), the energy stored when charging to voltage U_s is $\Delta W_C = \frac{1}{2} C \cdot U_s^2$.

Energy Consideration on the Resistor

The converted energy can also be determined for the resistor:

$$\begin{aligned} \Delta W_R &= \int_0^t u_R \cdot i_R \cdot dt = \int_0^t R \cdot i_R \cdot i_R \cdot dt \\ &= R \cdot \int_0^t i_R^2 \cdot dt \end{aligned}$$

Since the current through the capacitor i_C is equal to that through the resistor i_R , it follows via (5.2.2):

$$\begin{aligned} \Delta W_R &= R \cdot \int_0^t \left(\frac{U_s}{R} \cdot e^{-\frac{t}{\tau}} \right)^2 \cdot dt \\ &= \frac{U_s^2}{R} \cdot \int_0^t e^{-\frac{2t}{\tau}} \cdot dt \\ &= \frac{U_s^2}{R} \cdot \left[-\frac{\tau}{2} \cdot e^{-\frac{2t}{\tau}} \right]_0^t \\ & \quad \& | \text{with } \tau = R \cdot C \\ &= \frac{1}{2} \cdot U_s^2 \cdot C \cdot \left[1 - e^{-\frac{2t}{\tau}} \right] \end{aligned}$$

For $t \rightarrow \infty$ we get:

$$\begin{aligned} \Delta W_R &= \frac{1}{2} \cdot U_s^2 \cdot C \cdot \left[1 - e^{-\frac{2t}{\tau}} \right] \\ & \rightarrow \frac{1}{2} \cdot U_s^2 \cdot C \end{aligned}$$

$$\cdot \left[0 - 1 \right] \quad \boxed{\Delta W_R = \frac{1}{2} U_{\text{rms}}^2 \cdot C} \quad \text{\tag{5.2.4}}$$

This means that the energy converted at the resistor is independent of the resistance value (for an ideal constant voltage source U_{rms} and given capacitor C)! At first, this doesn't really sound comprehensible. No matter if there is a very large resistor R_1 or a tiny small resistor R_2 : The same waste heat is always produced. Graphically, this apparent contradiction can be resolved like this: A higher resistor R_2 slows down the small charge packets Δq_1 , Δq_2 , ... Δq_n more strongly. But a considered single charge packet Δq_k will nevertheless pass the same voltage across the resistor R_1 or R_2 since this is given only by the accumulated packets in the capacitor: $u_r = U_{\text{rms}} - u_C = U_{\text{rms}} - \frac{q}{C}$.

In real applications, as mentioned in previous chapters, ideal voltage sources are not possible. Thus, without a real resistor, the waste heat is dissipated proportionally to the internal resistance of the source and the internal resistance of the capacitor. The internal resistance of the capacitor depends on the frequency but is usually smaller than the internal resistance of the source.

Consideration of total energy turnover

In the previous considerations, the energy conversion during the complete charging process was also considered. It was found that the capacitor stores the energy $W_C = \frac{1}{2} U_{\text{rms}}^2 \cdot C$ (see (5.2.3)) and at the resistor the energy $W_R = \frac{1}{2} U_{\text{rms}}^2 \cdot C$ (see (5.2.4)) into heat. So, in total, the voltage source injects the following energy:

$$\Delta W_0 = \Delta W_R + \Delta W_C = U_{\text{rms}}^2 \cdot C$$

This also follows via (5.2.1):

$$\begin{aligned} \Delta W_0 &= \int_0^{\infty} u_0 \cdot i_0 \cdot dt \quad | \quad u_0 = U_{\text{rms}} \quad \text{\textit{is constant because constant voltage source!}} \\ &= U_{\text{rms}} \cdot \int_0^{\infty} i_C \cdot dt \quad | \quad i_C = \frac{dq}{dt} \\ &= U_{\text{rms}} \cdot \int_0^Q dq = U_{\text{rms}} \cdot Q \quad | \quad \text{\textit{where } } Q = C \cdot U_{\text{rms}} \\ &= U_{\text{rms}}^2 \cdot C \end{aligned}$$

This means that only half of the energy emitted by the source is stored in the capacitor! Again, This doesn't really sound comprehensible at first. And again, it helps to look at small packets of charge that have to be transferred from the ideal source to the capacitor. [figure 8](#) shows current and voltage waveforms across the capacitor and the stored energy for different resistance values. There, too, it can be seen that the maximum stored energy (dashed line in the figure at right) is given by $W = \frac{1}{2} U_{\text{rms}}^2 \cdot C$ alone. $U_{\text{rms}}^2 \cdot C = \frac{1}{2} \cdot (5 \text{ V})^2 \cdot 1 \text{ } \mu\text{F} = 12.5 \text{ } \mu\text{Ws}$ is given.

Fig. 8: Current, voltage, and energy during charging and discharging

μ

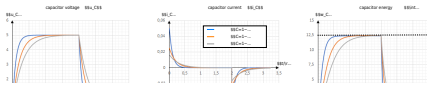

This can also be tested in the following simulation. In addition to the RC element shown so far, a power meter and an integrator are also drawn here. It is possible to display the instantaneous power and the stored energy. Via the slider Resistance R the resistance value can be varied. The following values are shown in the oscilloscopes:

- left: Current i_C and voltage u_C at the capacitor.
- middle: Instantaneous power $p_C = u_C \cdot i_C$ of the capacitor.
- right: stored energy $w_C = \int u_C \cdot i_C \, dt$ of the capacitor

Exercises

Exercise 5.2.1 Capacitor charging/discharging practice Exercise



Exercise E Exercise 5.2.2 Capacitor charging/discharging

The following circuit shows a charging/discharging circuit for a capacitor.

The values of the components shall be the following:

- $R_1 = 1 \text{ k}\Omega$

- $R_2 = 2 \text{ k}\Omega$
- $R_3 = 3 \text{ k}\Omega$
- $C = 1 \text{ }\mu\text{F}$
- S_1 and S_2 are opened (open-circuit)

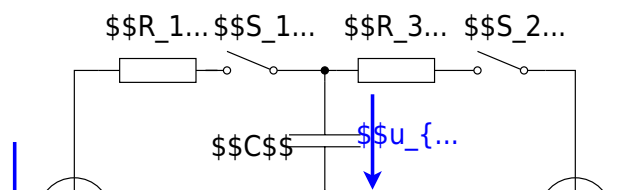

1. For the first task the switch S_1 gets closed at $t = t_0 = 0 \text{ s}$.

1.1 What is the value of the time constant τ_1 ?

1.2 What is the formula of the voltage u_{R2} over the resistor R_2 ? Derive a general formula without using component values!

2. At a distinct time t_1 the voltage u_C is charged up to $\frac{4}{5} \cdot U_1$. At this point of time, the switch S_1 will be closed.

Calculate t_1 !

3. The switch S_2 will get closed at the moment $t_2 = 10 \text{ }\mu\text{s}$.

3.1 What is the new time constant τ_2 ?

3.2 Calculate the moment t_3 , when u_{R2} is smaller than $\frac{1}{10} \cdot U_2$

3.3 Draw the course of time of the voltage $u_C(t)$ over the capacitor.

Exercise E5.2.2 Charge balance of two capacitors (educational exercise, not part of an exam)

In the simulation, you see the two capacitors C_1 and C_2 (The two small resistors with $1 \mu\Omega$ have to be there for the simulation to run). At the beginning, C_1 is charged to 10 V and C_2 to 0 V . With the switches S_1 and S_2 you can choose whether

1. the capacitances C_1 and C_2 are shorted, or
2. the capacitors C_1 and C_2 are connected via resistor R .

On the right side of the simulation, there are some additional “measuring devices” to calculate the stored potential energy from the voltages across the capacitors.

In the following, the charging and discharging of a capacitor are to be explained with this construction.

Under the electrical structure, the following quantities are shown over time:

Voltage $u_1(C_1)$ of the first capacitor	Voltage $u_2(C_2)$ of the second capacitor	Stored energy $w_1(C_1)$	Stored energy $w_2(C_2)$	Total energy $\sum w$
Initially charged to 10 V	Initially neutrally charged (0 V)	Initially holds: $w_1(C_1) = \frac{1}{2} \cdot C \cdot U^2 = \frac{1}{2} \cdot 10 \mu\text{F} \cdot (10 \text{ V})^2 = 500 \mu\text{W}$ In the oscilloscope, equals $1 \text{ V} \cdot 1 \text{ W}$	Initially, $w_2(C_2) = 0$, since the capacitor is not charged.	The total energy is $w_1 + w_2 = w_1$

The capacitor C_1 has thus initially stored the full energy and via closing of the switch, S_2 one would expect a balancing of the voltages and an equal distribution of the energy $w_1 + w_2 = 500 \mu\text{W}$.

1. Close the switch S_2 (the toggle switch S_1 should point to the switch S_2). What do you find?
 1. What do the voltages u_1 and u_2 do?
 2. What are the energies and the total energy?
How is this understandable with the previous total energy?
2. Open S_2 - the changeover switch S_1 should not be changed. What do you find?
 1. What do the voltages u_1 and u_2 do?
 2. What are the energies and the total energy?
How is this understandable with the previous total energy?
3. Repeat 1. and 2. several times. Can anything be deduced regarding the distribution of energy?
4. Change the switch S_2 to the resistor. What do you observe?

1. What do the voltages u_1 and u_2 do?
2. What are the energies and the total energy?
How is this understandable with the previous total energy?

Exercise 5.2.3: Charging and Discharging of RC elements (exam task, ca. 11 % of a 60-minute exam, WS2020)

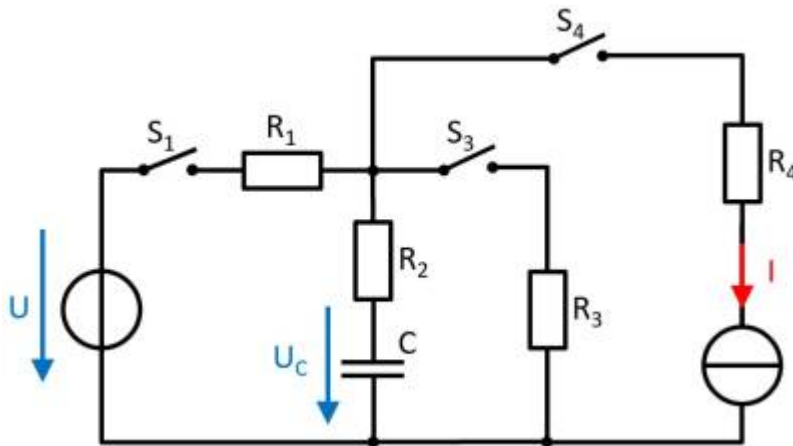

The circuit shown right is given with the following data:

- $U = 10 \text{ V}$
- $I = 4 \text{ mA}$
- $R_1 = 100 \text{ }\Omega$, $R_2 = 80 \text{ }\Omega$, $R_3 = 50 \text{ }\Omega$, $R_4 = 10 \text{ }\Omega$
- $C = 40 \text{ nF}$

At first, the voltage drop on the capacitor $u_C = 0$, and all switches are open. The switch S_1 will be closed at $t = 0$.

Simulation

1. Determine the time constant τ for this charging process.

Tips

- What equivalent circuit can be found for the mentioned states of the switches?
- What parameter do you need to determine τ ?
- The charging current is flown through which component?

Solution

The electrical components R_1 , R_2 , and C are connected in series with a source U . The time constant τ is therefore:
$$\tau = (R_1 + R_2) \cdot C = 180 \text{ }\Omega \cdot 40 \text{ nF}$$

Final value

$$\tau = 7.2 \text{ } \mu\text{s}$$

2. What is the value of the voltage $u_C(t)$ drop over the capacitor C at $t=10 \text{ } \mu\text{s}$?

Solution

$$U_C(t) = U \cdot (1 - e^{-t/\tau}) \quad U_C(t) = 10 \text{ V} \cdot (1 - e^{-10 \text{ } \mu\text{s} / 7.2 \text{ } \mu\text{s}})$$

Final value

$$U_C(t) = 7.506 \text{ V} \rightarrow 7.5 \text{ V}$$

3. What is the value of the stored energy in the capacitor, when it is fully charged?

Solution

$$W_C = \frac{1}{2} C U^2 = \frac{1}{2} \cdot 40 \text{ nF} \cdot (10 \text{ V})^2$$

Final value

$$W_C = 2 \text{ } \mu\text{J}$$

4. Determine the new time constant when the switch S_1 will be opened and the switch S_3 will be closed simultaneously.

Solution

The capacitor C discharges by the series connected resistors R_2 und R_3 .

$$\tau = (R_2 + R_3) \cdot C = 130 \text{ } \Omega \cdot 40 \text{ nF}$$

Final value

$$\tau = 5.2 \text{ } \mu\text{s}$$

5. When the capacitor is completely discharged, all switches will be opened. The switch S_4 will be closed at $t= 0$.

What is the voltage u_C at the capacitor C after $t = 1 \text{ } \mu\text{s}$?

Tips

- Through the current source there is a continuous flow of electric charge into the capacitor.
- The resistors passed by the current on the way to the capacitor are irrelevant. They only increase the voltage of an ideal current source to guarantee the current.

Solution

The voltage U_C is in general: $U_C = \frac{Q}{C}$. In this case, the constant current I results in $Q = \int I \, dt = I \cdot t$

$$U_C(t) = \frac{Q}{C} = \frac{I \cdot t}{C} = \frac{4 \cdot 10^{-3} \, \text{A} \cdot 1 \cdot 10^{-6} \, \text{s}}{40 \cdot 10^{-9} \, \text{F}} = 1 \, \text{V}$$

Final value

$$U_C(1 \, \mu\text{s}) = 1 \, \text{V}$$

From:

<https://wiki.mexle.org/> - **MEXLE Wiki**

Permanent link:

https://wiki.mexle.org/electrical_engineering_1/dc_circuit_transients?rev=1701392708

Last update: **2023/12/01 02:05**

