

Block 21 – Op-Amp Basics

Student Group

First Name	Surname	Matrikel Nr.

Table of Contents

- Block 21 – Op-Amp Basics** 2
- Learning objectives* 2
- Preparation at Home* 2
- 90-minute plan* 2
- Conceptual overview* 2
- Core content* 2
- Introductory example 2
- Circuit symbols and basic circuitry 4
- Notice: opamp input 7
- Basic Equation / Golden Rules 8
- Remember: basic equation and golden rules 9
- Real operational amplifier 10
- Power supply of the operational amplifier 11
- Feedback 11
- Note: feedback, positive feedback, negative feedback 13
- Note: Gain factors 13
- Common pitfalls* 13
- Exercises* 13
- Worked examples 14
- Embedded resources* 14

Block 21 — Op-Amp Basics

Learning objectives

After this 90-minute block, you can

- ...

Preparation at Home

Well, again

- read through the present chapter and write down anything you did not understand.
- Also here, there are some clips for more clarification under 'Embedded resources' (check the text above/below, sometimes only part of the clip is interesting).

For checking your understanding please do the following exercises:

- ...

90-minute plan

1. Warm-up (x min):
 1.
2. Core concepts & derivations (x min):
 1. ...
3. Practice (x min): ...
4. Wrap-up (x min): Summary box; common pitfalls checklist.

Conceptual overview

1. ...

Core content

Introductory example

Acoustic amplifiers, such as those found in mobile phones, laptops, or hi-fi systems, often exhibit an unpleasant characteristic when heavily amplified: the previously undistorted signal is no longer passed on as usual, but **clatters**. It is distorted in such a way that it no longer

sounds pleasant.

For this purpose, you will find an acoustic example with pictures in [figure 1](#) and [figure 2](#) respectively. The bottom of each image shows the time course of the voltage output to a loudspeaker (x-axis: time, y-axis: frequency). The upper picture has three dimensions: It shows in color intensity which frequencies are used at which time. The frequencies in grey areas are not used. If a frequency is shown in red at one point in time, it has a relatively large amplitude.

Fig. 1: undistorted signal

[hallo.mp3](#)



Fig. 2: overdriven signal

[hallo_verzerrt.mp3](#)



It can be seen that the distorted signal has large amplitudes in the time course of the voltage as well as a wide distribution of frequencies (= a broad spectrum).

The high frequencies in particular can promote wear of the diaphragm in loudspeakers.

The signal distortion is due to the design of the amplifier, which can only output the maximum possible voltage and otherwise [clipping](#).

The structure of an acoustic amplifier is similar to that of a feedback operational amplifier, as seen in the simulation.

Acoustic amplifiers are usually constructed like operational amplifiers, which will be considered in the following chapters.

Circuit symbols and basic circuitry

This chapter deals with operational amplifiers. One application for these are the measurement of voltages, currents, and resistances.

These values must be determined very precisely in some applications, for example for accurate temperature measurement. In this case, amplification of the measurement signals is useful and necessary.

This amplification is done by measuring amplifiers. Measuring amplifiers have to fulfill some characteristics.

Measurement amplifiers should ..

- ... **not have any feedback effect** on the measured variable.
An operational amplifier should have the highest possible input resistance. This prevents the voltage to be amplified from collapsing.
- ... have a **high sensitivity**.
An operational amplifier should have a large differential gain A_{D} .
- ... should show a **defined transmission behavior**, i.e. the output signal should be clearly related to the input signal.
An operational amplifier concretely should show a linear relationship.
- ... show **good dynamic behavior**.
The output signal of an operational amplifier should follow the input signal without any time delay.
- ... produce an **impressed output signal**.
This means that the components at the amplifier output cannot change the output signal.
An operational amplifier, specifically, should be able to maintain the desired output signal with the necessary current to do so.
Since the current I_{O} can become very large (by electronic standards), this means that an operational amplifier must have a low output resistance $R_{\text{O}} = \frac{U_{\text{O}}}{I_{\text{O}}}$.

Fig. 3: Equivalent circuit diagram of an amplifier

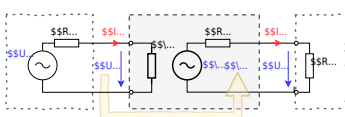

In general, an operational amplifier can be interpreted as a blackbox as in [figure 3](#).

The real interior is quiet complex and needs an understanding of the transistor, as shown in the

Architecture of the "simple" uA741.

Therefore, these chapter only focusses on the blackbox interpretation.

The circuit symbol of the amplifier is an isosceles triangle, at the apex of which the output signal originates and at the base of which the input signal enters.

In figure 4 you can see different circuit symbols:

Fig. 4: Circuit Symbols of Amplifiers

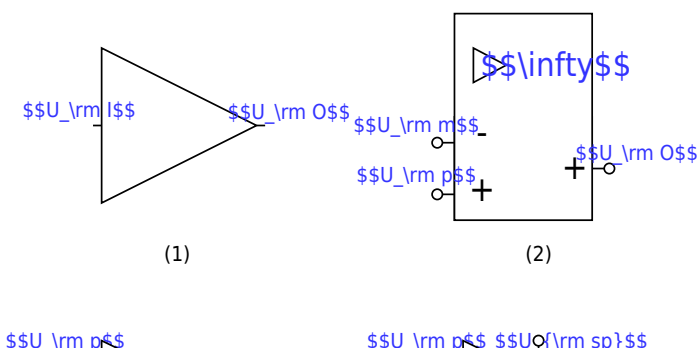

- Circuit symbol (1):
In block diagrams (not to be confused with circuit diagrams) this circuit symbol is used for general amplifiers. In block diagrams in interaction from an output back to the input exist, except there is an explicit path shown.
- Circuit symbol (2):
According to DIN EN 60617, this circuit diagram is to be used for operational amplifiers. It indicates with the infinity sign the ideally infinitely high amplification. In the following this symbol is not used, because it is not used in all international circuits and tools.
- Circuit symbol (3):
The circuit symbol (3) is the most commonly used symbol for an operational amplifier. On the left is the **inverting input** with voltage U_{m} (minus) and the **non-inverting input** with U_{p} (plus). The output with voltage U_{O} is shown on the right.
- Circuit symbol (4):
The circuit symbol (4) is additionally drawn with the supply voltages U_{sp} (supply plus) and U_{sm} (supply minus).
Power is provided from the supply for the output voltage of the operational amplifier.
- Circuit symbols (5) and (6):
these symbols show **no** operational amplifier. These symbols show the NOT gate and the tri-state gate.
Unfortunately, the representation of these digital components in various circuits is not unlike the operational amplifier.
An example of this is the transceivers¹⁾ [SP3481](#) or [SP3485](#). If digital input values are considered, assuming that the circuit symbol does not represent an operational amplifier.

Notice: opamp input

Fig. 5: Voltages at the operational amplifier



The inputs of the operational amplifier are designated as **inverting input** U_m and **non-inverting input** U_p .

The voltage $U_D = U_p - U_m$ is called the differential voltage (see [figure 5](#)).

Basic Equation / Golden Rules

The operational amplifier is a voltage amplifier. It simply measures on one side the voltage (like a voltmeter) and provides an amplified voltage on its output (like a voltage source).

Thus, for the ideal case, the input resistance must be infinite (like for a voltmeter) and the output resistance $R_O = 0$ (like for a voltage source).

The [figure 6](#) shows an ideal voltage amplifier.

This is characterized by the following properties:

- **Input resistance:**

The input side is drawn in the figure.

The resistance given here is the differential resistance R_D where the differential voltage U_D drops.

Therefore, $R_D \rightarrow \infty$ is valid. Thus, the input currents $I_p \rightarrow 0$ and $I_m \rightarrow 0$.

- **Output resistance, Basic equation:**

On the output side, $R_O = 0$ gives that $U_O = A_D \cdot U_D$.

This is the basic equation of the amplifier circuit.

Ideally, the op-amp amplifies linearly, as indicated in the equation. Specifically, for a differential voltage of U_D , the output voltage is $A_D \cdot U_D$.

• **Voltage Gain:**

A_D is very large.

Ideally, the following applies: $A_D \rightarrow \infty$

Fig. 6: Operational amplifier equivalent circuit

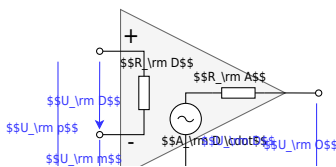

Remember: basic equation and golden rules

1. The output voltage depends on the differential voltage via the differential gain: $U_O = A_D \cdot U_D$ This is the **basic equation** of the amplifier circuit.
2. The **golden rules** of the ideal amplifier are:
 1. The differential gain goes to infinity: $A_D \rightarrow \infty$
 2. The input resistance goes to infinity: $R_D \rightarrow \infty$
 3. The output resistance is 0: $R_O = 0$

In figure 7 a simulation of an ideal amplifier is shown. The input source specifies the voltage to be amplified. The amplifier with an amplification factor of 100 has the connections for input and output voltage are drawn in. On the right side, a resistor is provided as load; this can be varied via a switch.

Fig. 7: Ideal Amplifier

In the simulation some characteristics of an amplifier can be seen:

1. Ideally, no current flows into the amplifier on the input side.
2. The current on the output side depends on the connected load. If the load resistance is reduced with the help of the switch, the current increases. The amplifier thus tries to maintain the desired voltage.
3. On the output side of the amplifier, the current can flow in either direction. The amplifier adjusts the current so that the amplified voltage $U_A = \pm 2.5 \text{ V}$ can be measured at the output.

Real operational amplifier

These rules have different limits in the real amplifier:

- Output voltage $\boldsymbol{U_{\text{O}}} = A_{\text{D}} \cdot U_{\text{D}}$:
 - The output voltage can only follow the input voltage as far as the power supply allows. In real operational amplifiers, only so-called **rail-to-rail** operational amplifiers can exploit the range down to a few 100 mV to U_{S} . Other operational amplifiers have an **output limit**, which is $1 \dots 2 \text{ V}$ below the supply voltage.
 - If the supply voltages are not symmetrical ($U_{\text{sm}} \neq -U_{\text{sp}}$), then the characteristic also shifts.
 - The ideal operational amplifier produces the same output voltage $U_{\text{O}} = A_{\text{D}} \cdot U_{\text{D}}$ as long as $U_{\text{D}} = U_{\text{p}} - U_{\text{m}}$ is the same. For the real operational amplifier with fixed A_{D} , output voltage U_{O1} for $U_{\text{D1}} = 5 \text{ V} - 4.9 \text{ V}$ is different from U_{O2} for $U_{\text{D1}} = 0.1 \text{ V} - 0 \text{ V}$.
- Differential gain $\boldsymbol{A_{\text{D}}}$:

The differential gain is usually between $A_{\text{D}} = 20'000 \dots 400'000$.
- Input resistance $\boldsymbol{R_{\text{D}}}$:

For real operational amplifiers, the input resistance $R_{\text{I}} > 1 \text{ M}\Omega$ and the input current $|I_{\text{p}}|$ or $|I_{\text{m}}|$ is less than $1 \text{ }\mu\text{A}$.
- Output resistance $\boldsymbol{R_{\text{O}}}$:

In real operational amplifiers, the output resistance R_{O} is usually a few Ω and limited by a maximum current (in the range of a few tens of mA to a few A)

The simulation shows a **(simulated) real amplifier**. The input source has a high internal resistance. This means it has a high impedance and can only supply a small amount of current. The amplifier with a gain of 100 has - besides the connections for input and output voltage - also connections for the supply voltage drawn in. On the right side, a resistor is provided as load; this can be varied via a switch.

In the simulation some properties of an amplifier can be seen:

1. On the input side, a small current flows into the amplifier.
2. The current on the output side depends on the connected load. If the load resistance is reduced with the help of the switch, the current increases. The amplifier thus tries to maintain the desired voltage.
3. The amplifier can output current as well as absorb current.
The current on the output side flows in and out of the amplifier through the supply voltage connections.
4. The simulation is based on a real amplifier. This has a small deviation from the expected value $U_{\text{O}} = \pm 2.5 \text{ V}$ at the output voltage. Part of the deviation will be described later in this chapter.

Power supply of the operational amplifier

For the voltage supply of the operational amplifier, a distinction is made between unipolar and bipolar:

With the **bipolar voltage supply**, the same voltage levels but with different signs are applied to both supply terminals in terms of magnitude.

This allows the output voltage U_{O} of the amplifier to point in either direction.

The power supply must be designed in such a way that it can provide both voltages. A differential voltage of $U_{\text{D}} = 0$ also results in an output voltage of $U_{\text{O}} = 0$.

With the **unipolar power supply**, the negative supply terminal is connected to the ground.

As a result, the output voltage U_{O} of the amplifier can only take on non-negative values. In this case, the supply can be provided by a single voltage source (e.g., a battery).

With a differential voltage of $U_{\text{D}} = 0$, the output voltage is $U_{\text{O}} = \frac{1}{2} \cdot U_{\text{sp}}$.

The op-amps in the simulation replicate real op-amps in some respects: The voltage gain is $A_{\text{D}} = 100'000$.

The transfer characteristics $U_{\text{O}}(U_{\text{D}})$ show proportional behavior only when the output value is smaller in magnitude than the supply voltage $|U_{\text{sp}}| = |U_{\text{sm}}| = 5 \text{ V}$ (not shown).

The modulation limits and the voltage gain can be changed in the simulation via “Edit component” (double click).

Fig. 8: unipolar and bipolar supply

Feedback

One of the fundamental principles of control engineering, digital technology, and electronics is **feedback**.

A feedback is given when the output value of a system is routed back as to its input.

Here, the output voltage of the operational amplifier fed back to the input.

In addition, there is another tool for control engineering, digital systems, and electronics: the **block diagram** or signal flow diagram.

Up to now, only circuit diagrams have been used so far. With circuit diagrams there is an interaction of all components due to Kirchhoff's rules.

Furthermore, voltage differences or current can be measured over all components.

The block diagram is different. It shows individual blocks linked into a chain of cause-and-effect.

In general, no reaction of the effect on the cause is assumed. Causes and effects can be voltages or currents, which are then written on the respective connecting arrow.

The block diagram does not claim to conserve energy or charge but serves to provide an overview of the effects and interrelationships. Thus Kirchhoff's rules are usually not applicable there.

figure 9 shows a block diagram of a feedback amplifier consisting of an ideal voltage amplifier with gain A_D drawn in the center. The output voltage U_O , reduced by the factor k , is fed back via a feedback element. The circle symbol with the arithmetic symbols (in the block diagram on the left) shows how the incoming values must be offset against each other. The value $k \cdot U_O$ is thus subtracted from the input value U_I in the indicated block diagram.

Fig. 9: Block diagram of an amplifier with feedback



Fig. 8: unipolar and bipolar supply

The advantage of a real amplifier in negative feedback is that the gain A_{V} of the whole system depends only negligibly on the gain factor A_{D} of the real amplifier if A_{D} is very large (see also task 1.3.2). In this case, the gain $A_{\text{V}} = \frac{1}{k}$. To avoid oscillation of the whole system, the amplifier must contain a delay element. This is present in the real amplifier in such a way that the output voltage U_{O} cannot change infinitely fast.²⁾

Note: feedback, positive feedback, negative feedback

Feedback (German: **Rückkopplung**) refers to the return of part of the output signal of an amplifier.

With **positive feedback** (German: **Mitkopplung**), output signal is partially routed back with a positive sign.

The output value U_{O} therefore always increases the input value U_{D} .

With **negative feedback** (German: **Gegenkopplung**), output signal is partially routed back with a negative sign.

The output value U_{O} therefore always attenuates the input value U_{D} .

Note: Gain factors

The **differential gain** or **open-loop gain** A_{D} (German: Differenzverstärkung) refers only to the input and output voltage of the inner amplifier: $A_{\text{D}} = \frac{U_{\text{O}}}{U_{\text{D}}}$. This acts only without external feedback. It is also called open-loop gain.

The **voltage gain** A_{V} refers to the input and output voltage of the whole circuit with feedback: $A_{\text{V}} = \frac{U_{\text{O}}}{U_{\text{I}}}$. It is also called closed-loop gain.

¹⁾ transmitter and receiver, meaning transmitter-receiver, or interface adapter

²⁾ That a voltage change can only take place in a finitely long time is also true for the input voltage. However, this cannot be influenced by the amplifier, but is externally specified.

Common pitfalls

- ...

Exercises

Worked examples

...

Embedded resources

What is an operational amplifier?

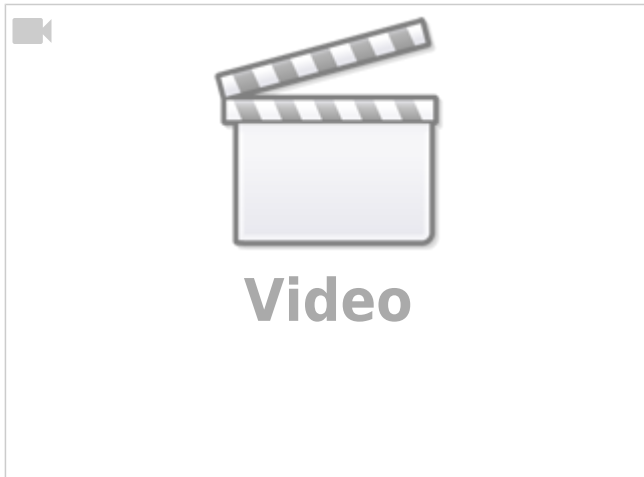

From:

<https://wiki.mexle.org/> - **MEXLE Wiki**

Permanent link:

https://wiki.mexle.org/electrical_engineering_and_electronics_1/block21?rev=1765653555

Last update: **2025/12/13 20:19**

