

# Für ARSnova

## Student Group

First Name	Surname	Matrikel Nr.

## Table of Contents

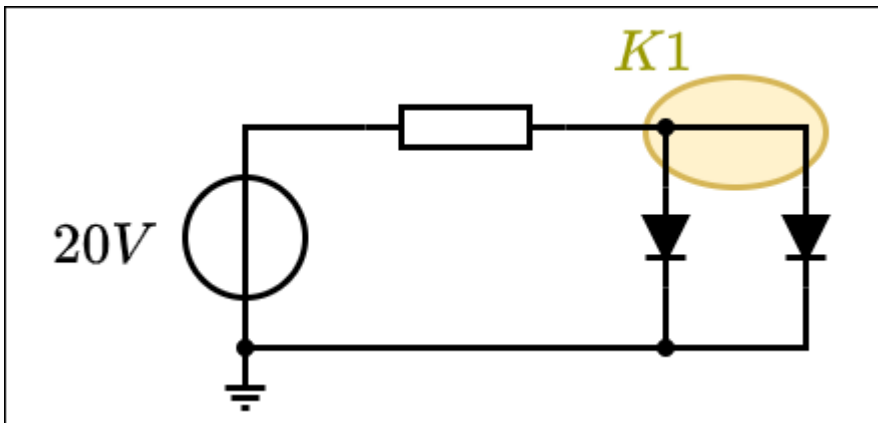
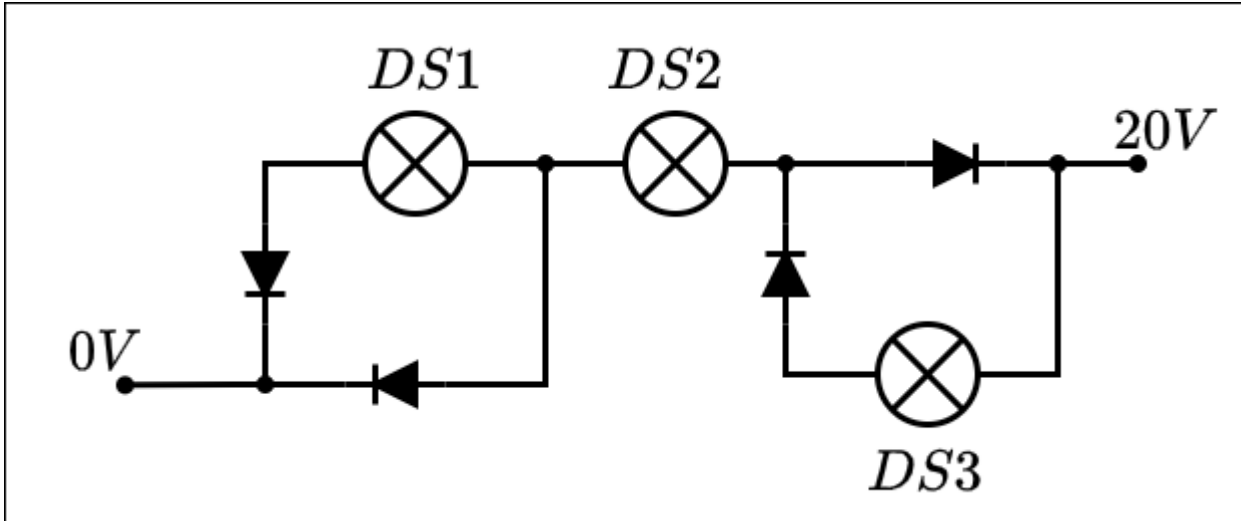
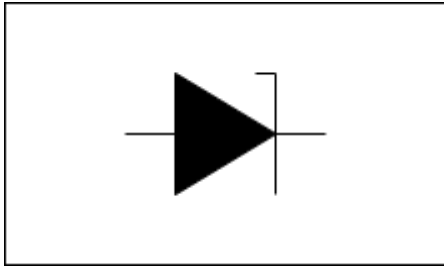



From:  
<https://wiki.mexle.org/> - **MEXLE Wiki**

Permanent link:  
[https://wiki.mexle.org/elektronische\\_schaltungstechnik/fuer\\_arsnova?rev=1650482665](https://wiki.mexle.org/elektronische_schaltungstechnik/fuer_arsnova?rev=1650482665)

Last update: **2022/04/20 21:24**

