

1 Boolean Algebra

Student Group

First Name	Surname	Matrikel Nr.

Table of Contents

- 1. Boolean Algebra** 3
 - 1.1 Motivation: Digital electronics in daily life** 3
 - Learning Objectives 3
 - 1.1.1 Everything is one except zero... 3
 - Note! 5
 - 1.1.2 At the heart of a computer 5
 - 1.2 Binary Logic** 8
 - Learning Objectives 8
 - 1.2.1 First steps into logic 8
 - 1.2.2 The logic operator NOT 9
 - Note! 10
 - 1.2.3 The logic operator AND 10
 - 1.2.4 The logic operator NAND 11
 - 1.2.5 The logic operator OR 12
 - 1.2.6 The logic operator XOR 13
 - Exercise 1.2.1. NOR and XNOR 14
 - 1.2.7 The Tri-State Gate 14
 - Example of an Application for a Tri-State Gate 16
 - 1.3 Timing Diagram - A Deep Dive** 17
 - Learning Objectives 17
 - 1.4 Convertibility of gates** 17
 - Learning Objectives 17
 - 1.4.1 NAND in NOT 18
 - 1.4.2 NAND in AND 18
 - 1.4.3 NAND in OR 18
 - 1.5 Rules for boolean algebra** 18
 - Learning Objectives 19
 - 1.5.1 The set of rules 19
 - math representation 19

- algebraic representation 20
- 1.5.2 Dive into Distributive Law 21
- 1.5.3 Dive into Law of Absorbtion 22
- 1.5.4 Dive into DeMorgan's Rule 22
- 1.5.5 Example of a logic simplification 23
- 1.6 Examples of gate circuits** 23
- 1.6.1 Logic gates with multiple inputs 23
 - Exercise 1.6.1. Other gates with multiple inputs 23
- 1.6.2 Switchable inverter 23
- 1.6.3 Data valve 24
- 1.6.4 Multiplexer and Demultiplexer 24
- related Links** 24
- Applications 25
- Exercises 25
 - Exercise 1.6.2. truth tables 25
 - Exercise 1.6.3. timing diagram 25
 - Exercise 1.6.4. NAND-based gates 26
 - Exercise 1.6.5. NOR-based gates 26
 - Exercise 1.6.6. simplification of logic expressions 26
 - Exercise 1.6.7. only using NAND 26
 - Exercise 1.6.8. step by step example for logic simplification using boolean rules 27
 - Exercise 1.6.9. XOR in Cryptography 27
- References 27

1. Boolean Algebra

1.1 Motivation: Digital electronics in daily life

Learning Objectives

By the end of this section, you will be able to:

1. know the Boolean functions, their notations, and truth tables.
2. apply the Boolean rules of arithmetic.
3. simplify Boolean expressions.
4. know the following terms: (logic) gates, names of arithmetic rules.

1.1.1 Everything is one except zero...

Fig. 1: first Example: USB cable 

Before we start to dive deeper into the digital systems, it is a good idea to approach the topic with a first practical example. For this, we have a look onto an USB cable and mentally cut the cable. We will see a total of four wires waiting for us. Two of them are called D+ and D-. These are the wires that are used for digital data transmission. With special tools - like an oscilloscope we can measure the time course of the voltage between D+ and D-. This voltage is shows two different levels and rises and falls in between. What we see are the **logic states** \$0\$ or \$1\$! ¹⁾

Beyond data transmission, we can also encode other things with binary numbers: for example, we could look at

- the position of a lever - whether it is pointing up or down.
- or a switch that is open or closed.
- or a light that is on or off.
- even whether it is raining or not raining, whether a dog is barking or not barking or other things - we can encode all of that in binary units.

In reality, the measured voltage on the USB cable would also show noise and only roughly depict the

two states. When we ignore the noise and only assume that an upper level (\$HIGH\$ or \$H\$) encode one state and the lower one (\$LOW\$ or \$L\$) the second state the diagram is also called the **level diagram**. In contrast to analog systems, a signal can only take one of the two valid states in digital systems. Similarly, boolean algebra only uses the states \$TRUE\$ and \$FALSE\$.

Note!

- The smallest binary message set is called a “**bit**”, which comes from the English term “binary digit”. A bit thus describes the logical state of a two-valued system. The binary characters can be written as, e.g.:
 - \$0\$, \$1\$
 - \$FALSE\$, \$TRUE\$
 - \$HIGH\$, \$LOW\$
- In binary logic, every expression can only be **true or false**. If something is not true, it has to be false - and vice versa.
- Therefore, binary logic has some **limitations for real world applications**: It may only rain softly, a light might be dimmed and also the voltage (which represents the bit) might be in an in-between state. This situation has to be coped with beyond the binary logic. Beyond binary logic, there is often an **invalid state** in reality, which separates the logic states.

We will find out more of the details behind this states in the chapter [Number Systems](#). In this chapter we will start to think about, how this binary signals in connection with some algebra can generate a base for fundamental logic building blocks. This building blocks will be stacked together to larger boxes in the next chapters and are the basis for microcontroller, microprocessors and virtually all digital electronics from watches over automotive controllers to super computers.



Fig. 2: Inner 'Life' of an Integrated Circuit

1.1.2 At the heart of a computer

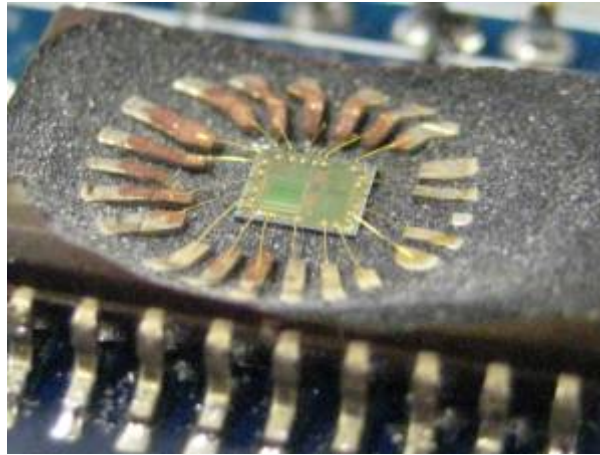

Fig. 3: A 'topless' microcontroller

The core of a computer is the processor in which the instructions are executed. This central processing unit (CPU) is also used in microcontrollers, which can be found around us in almost every device: Mobile phones, cars, bank cards, washing machines... Often there are even several microcontrollers installed in the devices.

In the microcontroller, in addition to the command-executing microprocessor (more precisely, the [arithmetic-logic unit](#)), other peripherals such as memory, clock generation, analog-to-digital converter and much more are built in. This makes it a compact tool for many applications. If you look at the microcontroller under an optical microscope, you will see the following picture ([figure 3](#)).

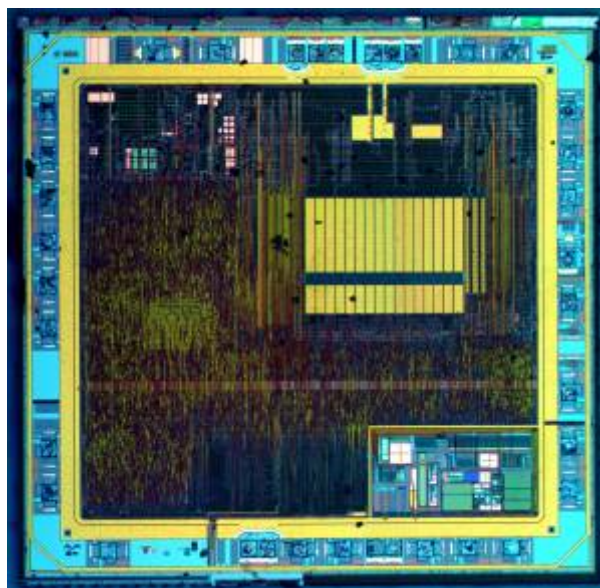

Fig. 4: Microcontroller under the microscope



Fig. 5: Microcontroller schematic

But now let's take a look at the structure of the processor. The processor shown in figure 4 and figure 5 was developed by two students in 1990 and consists of several tens of thousands of transistors. This chip paved the way to cheap, fast and yet easily programmable controllers, from the fax machine to the hobby basement, and can be found on the Arduino boards, among others. You will get to know and to program the ATmega328 - a distant successor with several hundred thousand transistors - in higher semesters. The images depict various peripheral components: The processor, FLASH, EEPROM and fuses will be shown in the following chapters. The voltage supply (German 'Spannungsversorgung'), is needed to generate additional higher voltages based on the supplied external voltage.

The following clip shows a zoom into the smallest parts of the controller.



One question is still unclear: how can we connect the zeros and ones in such a way, that the processor can calculate something like $23 + 42$? For this we need to have a look onto binary logic.

1.2 Binary Logic

Learning Objectives

By the end of this section, you will be able to:

1. know the Boolean functions, their notations, and truth tables.
2. apply the Boolean rules of arithmetic.
3. simplify Boolean expressions.
4. understand the following terms: bit, the different (logic) gates, timing diagram, truth table.
5. understand the purpose of the Tri-State gate and the "Z" state.
6. understand the use of the "Don't care" state.

1.2.1 First steps into logic

We have already learned about the 'bit', and its two-valued value. This can be connected to the ancient idea of a binary logic. The Greek Philosopher Aristotle started to build up a systematic in order to conclude from statements like 'at night, it is dark outside' and 'it is night' to 'it has to be dark outside'. It might seem a bit unrelated to controllers and computers, at the first sight. But in this scientific interpretation of logic all logic statements are either true or false.

[George Boole](#) developed a more mathematical way into handline logic. Based on his work the fundamental logic was solidified into axioms. One axiom we have already seen: If something is true, it cannot be false and vice versa (the 'theorem of contradiction').

Other axioms help to combine statements. This is called 'reasoning' or 'deduction'.

- This was already used some sentences before: If 'at night, it is dark outside' and 'it is night' is true, one can make the **implication** 'it has to be dark outside'. But be aware, that is is not always reversible: It could also be a solar eclipse.
- Another deduction is the **equivalence**: when '\$A\$' implies '\$B\$', and '\$B\$' implies '\$A\$' both statements are equivalent.

In the following, we will have a look onto the basic logic combinations, which are needed for digital systems. These basic logic combinations of logic statements (or bits) are called **logic operators** and can be used similarly to the algebraic "plus" or "minus". The mathematical construct, which describes the systematic of these combinations is called **boolean algebra**. In digital systems the logic operators can be represented as a circuit of transistors or switches. This can be blackboxed into **logic gates**.

This tools will get more familiar in the next subchapter.

A good introduction in binary logic



1.2.2 The logic operator NOT

Fig. 6: Simulation of an Inverter

The first very simple circuit negates the input value. It is also called an inverter or negation ([logic NOT](#), [NOT gate](#)). This logic operator always generates the output value $Y(0)=1$ from the digital input value $X=0$ and for $X=1$ correspondingly $Y(1)=0$. [figure 6](#) shows an example: The light is only on ($X=1$), when the input is off ($Y=0$) - this functionality is "hard-wired".

When you think about the inputs and outputs in the shown picture above, you realise, that the input is a voltage, but the output is a current. This is sometimes beneficial, but inside an digital systems commonly only voltages are used.

Fig. 7: Simulation of an Inverter

In order to control a (output) voltage with a (input) voltage two complement types of switches are combined similar to a voltage divider or a half bridge (see [figure 7](#)). One is normally open and the other one normally closed. This can also set up with complement types of transistors. Thus, only one transistor (TRANSfer RESISTOR) becomes conductive at a time, the other one correspondingly high impedance.

With this setup the logic voltages ($0V$, $5V$) are just switched complementary via the switches. This technique is also called **CMOS** technique: Complementary MOSFET. In today's electronics, this technology is used throughout and has completely replaced older variants (e.g. TTL).

Comparing the circuits in [figure 6](#) and [figure 7](#), one could simply see, that double the amount of switches have to be used and the lower one is a bit trickier to understand. With this in mind, for the following operators only the first type of circuit will be shown.



Fig. 8: Negation: Circuit symbols

The circuit symbols of the NOT-gate are shown in figure 8. Depending on the (software) tools and schematics one of the type is printed.



Fig. 9: Negation: Truth table and timing diagram

Besides the symbol other representation are also common (see also figure 9):

- The **truth table** shows the input(s) X on the left and the output(s) Y on the right. There is a row for each distinct combination of inputs. This representation will get handy in the next chapters, in order to analyse more complex logic. Often instead they are also called **look-up table** or **LUT**.
- The **timing diagram** shows the sequential behavior. For this diagram, the input variables are stimulated with all possible state combinations. Also this will become handy especially in the chapter [Sequential Logic](#).
- In **math** the inversion has also multiple representations e.g.
 - $Y = /X$ (used e.g. for input with a keyboard)
 - $Y = \overline{X}$ (often used when handwriting and math)
 - $Y = !X$ (used in c language)

Note!

- Inputs are always denoted with X
- Outputs are always denoted with Y
- There are multiple ways for representing the logic. The most common ones are:
electric circuit with switches (or transistors), logic gate, truth table, timing diagram, mathematical representation.
- When you use a representation: use it uniformly.

1.2.3 The logic operator AND

Fig. 10: Simulation of a conjunction

The next circuit will generate an positive output only, if all inputs are true. This is called a logical **conjunction** (logic AND, AND gate). When one ore more inputs are false the output is also false. [figure 10](#) shows an example: The light is only on ($Y=1$), when all inputs are on ($X_0=1$, $X_1=1$, ...). This is commonly used for safety circuits, e.g. when the workspace of a robot has multiple doors and all have to be closed in order to start.

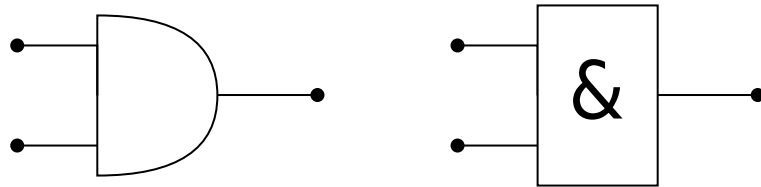

Fig. 11: Conjunction: Circuit symbols

international circuit symb...
Circuit symbol accord...

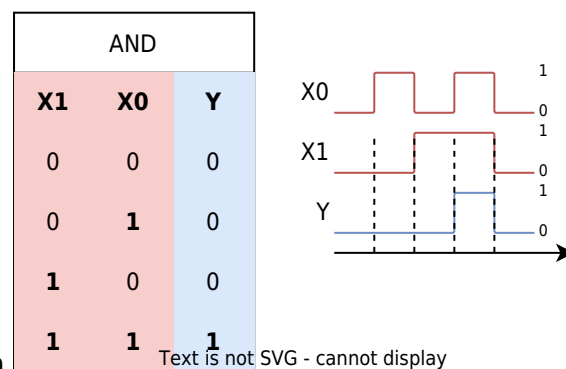

Fig. 12: Conjunction: Truth table and timing diagram

Text is not SVG - cannot display

Again, the other representation are shown:

- The truth table and timing diagram are depicted in [figure 12](#).
- In **math** the AND operation has again multiple representations e.g.
 - $Y = X_0 * X_1$ (used e.g. for input with a keyboard)
 - $Y = X_0 \cdot X_1$ (often used when handwriting or in math)
 - $Y = X_0 \& X_1$ (used in c language bitwise)
 - $Y = X_0 \wedge X_1$ (used in logic)

For upcoming, more complex terms the algebraic notation ($Y = X_0 \cdot X_1$) usually lead to a better understanding.

1.2.4 The logic operator NAND

Fig. 13: Simulation of a NAND operation

The NOT gate is often used in front of or after other gates. When used after AND gates, this creates an 'NOT AND' or in short 'NAND' (logic NAND, NAND gate). This circuit will only generate an negative output only, if all inputs are true. When one ore more inputs are false the output is true. [figure 13](#) shows an example: The light is only off ($Y=0$), when all inputs are high ($X_0=1$, $X_1=1$, ...). In

the simulation one has to look in detail: the used switches are normally closed (closed when the input is low). Therefore the switches are only open, when the input is high.

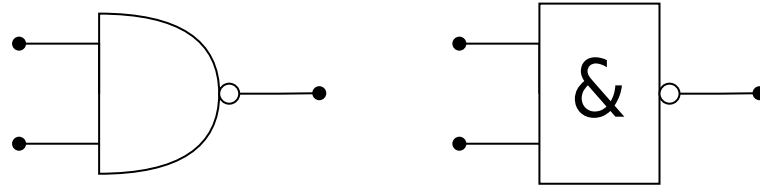

Fig. 14: NAND Circuit symbols

The circuit symbols are shown in figure 14. In order to shorten the circuit, the NOT is often 'shrunk' only to a small circle after the gate.

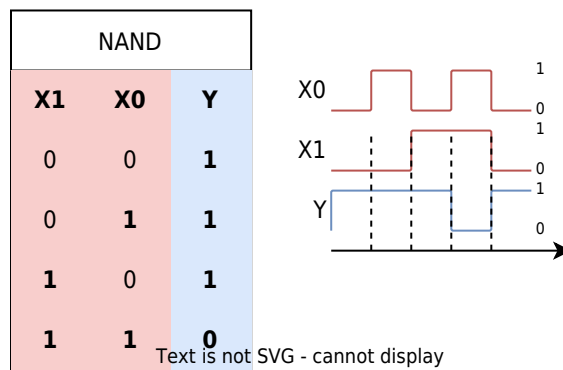

Fig. 15: NAND: truth table and timing diagram

Again, the other representation are shown:

- The truth table and timing diagram are depicted in figure 15.
- In **math** the NAND operation has again multiple representations e.g.
 - $Y = \overline{(X_0 * X_1)}$ (used e.g. for input with a keyboard)
 - $Y = \overline{(X_0 \cdot X_1)}$ or $Y = \overline{X_0 \cdot X_1}$ (often used when handwriting or in math)
 - $Y = \overline{(X_0 \& X_1)}$ (used in c language bitwise)
 - $Y = \overline{(X_0 \wedge X_1)}$ or $Y = \overline{X_0 \wedge X_1}$ (used in logic)

1.2.5 The logic operator OR

Fig. 16: Simulation of a OR operation

We already had a look onto the AND gate. So what about OR? Of course there is also this kind of operation. This is called a logical **disjunction** (logic OR, OR gate). When there is one or more input true the output is also true. figure 16 shows an example: The light is only off ($Y=0$), when all inputs are off ($X_0=0$, $X_1=0$, ...). Doesn't it - at the first glimpse - seem similar to the NAND circuit? The main difference is that normally open switches are used. Only, when both switches are open the light

is off.



Fig. 17: OR circuit symbols

The circuit symbols are shown in figure 17. The DIN symbol is derived from the fact, that one ore more inputs have to be true to get an true output.



Fig. 18: OR: truth table and timing diagram

Again, the other representation are shown:

- The truth table and timing diagram are depicted in figure 18.
- In **math** the OR operation has again multiple representations e.g.
 - $Y = X_0 + X_1$ (used e.g. for input with a keyboard or in handwriting)
 - $Y = X_0 \mid X_1$ (used in c language biswise)
 - $Y = X_0 \vee X_1$ (used in logic, the \vee stands for the Latin *vel*, which means or)

For upcoming, more complex terms the algebraic notation ($Y = X_0 + X_1$) usually lead to a better understanding. Also here: we will see the connection to math in the next chapters.

1.2.6 The logic operator XOR

Fig. 19: Simulation of a XOR operation

Beside the OR there is also an “either ... or ..., but not both”. This is called exclusive or, in short XOR (**logic XOR, XOR gate**). Only when one input is true the output is true. figure 16 shows an example: When none or when all inputs are on, the light is only off. The circuit looks a bit more complicated with two series branches in parallel and the use of both normally closed and normally open switches. On the other hand one can already think about, that one of the branches look similar to the setup for

the AND gate, and the parallel setup similar to the NAND gate. Could it be possible to convert the gates into each other? We will see that next...

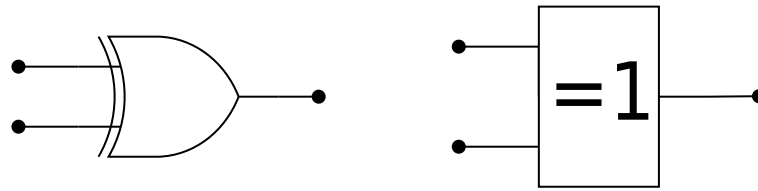

Fig. 20: XOR circuit symbols international circuit symbol Circuit symbol according to IEC 60617-1

The circuit symbols are shown in [figure 20](#). Both symbols have similarities with the OR symbols.

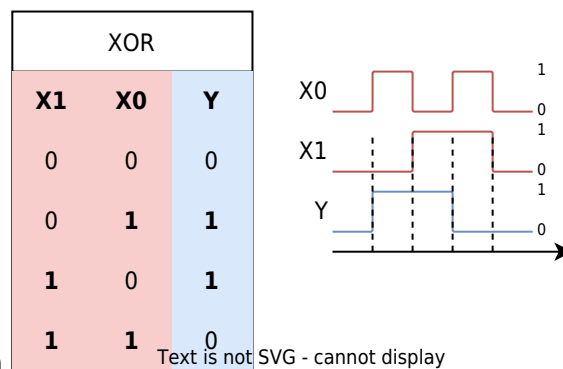

Fig. 21: XOR: truth table and timing diagram Text is not SVG - cannot display

Again, the other representation are shown:

- The truth table and timing diagram are depicted in [figure 21](#).
- In **math** the XOR operation has again multiple representations e.g.
 - $Y = X_0 \# X_1$ (used e.g. for input with a keyboard or in handwriting)
 - $Y = X_0 \wedge X_1$ (used in c language bitwise)
 - $Y = X_0 \oplus X_1$ (used in logic)

Exercise 1.2.1. NOR and XNOR

1. Think about a circuit (with multiple switches and one lamp) to implement NOR and XNOR.
2. What is the relation between the circuits of NOR and AND? And how about XOR and XNOR?
3. What would the gate representation and the other representations look like?

1.2.7 The Tri-State Gate

The [tri-state gate](#) is not a boolean gate, however it is still often used in logic circuits such as microcontrollers. The essence of the tri-state gate is - in short - to be able to output 'nothing'. Nothing means: neither high nor low.

One possible output of the tri-state gate - besides high and low - is 'high ohmic', which is often

referred as Z . In this case, the gate output is not controlled by the tri-state gate, but floats. The output can instead be controlled by an other external source. The main use of this gate is to disconnect one logic circuit from another one.

Fig. 22: Simulation of a Tri-State gate

figure 16 shows the function of a tri-state gate: When the EN enable input is set to high this gate becomes transparent and the output Y equals the input X . When EN is set to low, the output is not pinned to the input anymore. In the simulation above with $EN = 0$ the output voltage is clamped by the voltage behind the resistor (here $3V$). Since this voltage could be any value this output cannot called low or high, but is called the (undefined) state Z .



Fig. 23: Tri-State gate circuit symbols

international circuit symbols

The circuit symbol is shown in figure 23. Usually the triangle symbol is used, the DIN / EN symbol is much less common and therefore here ignored. Since the Tri-State gate is not an logical gate it does not have any mathematical representation.

Tri-State		
EN	X	Y
0	0	Z
0	1	Z
1	0	0
1	1	1



Alternative writing...

Tri-State		
EN	X	Y
0	-	Z
1	0	0
1	1	1

Fig. 24: Tri-State gate: truth table and timing diagram

Text is not SVG - cannot display

In the [figure 24](#) the truth table is shown. In the case $EN=0$ the input X does not matter. The situation 'the input x does not matter' is usually simplified by the use of a **don't care term**. The 'don't care' is written down as a x or a $-$.

Example of an Application for a Tri-State Gate

Let's imagine, we want to connect two microcontroller A and B in order to enable a communication, i.e. transmitting and receiving data on both sides.

One possibility would be to use two wires:

- One wire for data sent from A to B
- One wire for data sent from B to A

This is shown in [figure 25](#). You can change the inputs X_0 and X_1 by clicking on the L and H nearby this labels.

The big advantage of this configuration is, that both connected microcontroller can send data whenever they want. The biggest disadvantage is, that one need two wires.

Fig. 25: Simulation for Communication with two Wires

Once we think of only using one wire, it becomes more complicated: a single wire can only be driven by one digital input - only one can transmit data at any given time. Therefore, we have to switch on both sides from receive to transmit, e.g. by a Single Pole Double Throw switch. This can be seen in [figure 26](#) for the two situations " A sends data to B " and " B sends data to A ". Again, you can change the inputs X_0 and X_1 by clicking on the L and H nearby this labels.

The problem is, that in one time the output becomes an input, but boolean gates an algebra result everytime in boolean outputs.

Fig. 26: Simulation for Communication: first Try with one Wire

We still could try solve it with gates, as seen in [figure 27](#): Each microcontroller has an enable signal (EN_0 , EN_1). Both outputs from the microcontrollers have to be combined with another gate in such a way, that the result shows the enabled signal.

The problem here: We are back to a two wire system. So, we need to "split up" the OR gate somehow..

Fig. 27: Simulation for Communication: with only boolean Gates

For this we can use the Tri-State gate: This enables to switch an output to high ohmic. This

means this output does not provide any current anymore, so this output is not driven anymore.

Fig. 28: Simulation for Communication with Tri-State Gates

1.3 Timing Diagram - A Deep Dive

Learning Objectives

By the end of this section, you will be able to:

1. understand in which possible way the tri-state output is shown in timing diagrams
2. know how the situation 'either 0 or 1' is shown in timing diagrams

Since the timing diagram is of importance not only for the upcoming courses like Electronics (in the 3rd semester) I recommend to watch the following video sequence.

24 minutes intro into applications of the timing diagram in real data sheets (a cutout from 5:08 to 28:52 from a full video of EEVblog)

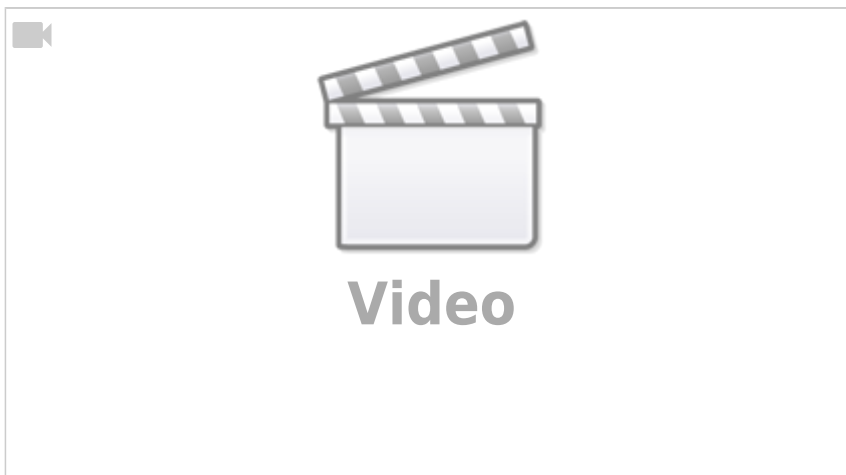

1.4 Convertibility of gates

Learning Objectives

By the end of this section, you will be able to:

1. convert simple gates into each other
2. convert interconnections from a few logic gates to truth tables and vice versa.

3. build-up other gates from NAND and NOR gates.

Some of the circuits in the previous chapter looked suspiciously similar. We will now have a more deeper look onto this and try to convert some gates into each other. In this subchapter we will focus on combining NAND gates in order to build other gates. As we will see, based on the NAND and NOR gates any other gate and any other logic can be created.

1.4.1 NAND in NOT

Fig. 29: From NAND to NOT

The conversion from NAND to NOT is relatively simple: When both inputs to NAND are the same (either '1' or '0') the output will be the negation of the input. This can also be seen in the truth table of the NAND gate: when the inputs are the same only the first and last row, have to be considered and lead to an inverting behaviour.

A different approach to get an NOT is to set the second input to '1'. Here, the NOT can be 'deactivated' with the second input. This can be tested in the [figure 29](#) by clicking on the input 'H' of the NAND gate on the right below.

1.4.2 NAND in AND

Fig. 30: From NAND to AND

With the knowledge from 'NAND to NOT' the NAND can be converted to AND: a negated NAND leads to an AND. It is roughly similar to 'not a no-go' is logically a 'go'. Therefore, the NOT hat to be set behind the NAND.

1.4.3 NAND in OR

Fig. 31: From NAND to OR

When each input of a NAND gate is inverted the result acts like an OR gate. In order to understand this, one can again look onto the truth table of the NAND and the OR gate and try to investigate what happens when the inputs of the NAND are negated.

1.5 Rules for boolean algebra

Learning Objectives

By the end of this section, you will be able to:

1. know and use the arithmetic rules in boolean algebra.

We have seen, that (at least) some of the gates can be represented by means of others. In order to approach this more systematically, we will now have a look onto the arithmetic rules of boolean algebra. These rules can be used to either build a logic circuit out of the basis gates shown in chapter 1.2. On the other hand we are also able to simplify the logic circuits by these rules.

1.5.1 The set of rules

The following table shows the main rules which help us to generate and optimize logic expressions and circuits.

It is possible to click on “math representation” and “algebraic representation” to switch both.

Have a look for the algebraic representation. These are probably much simpler to remember!

Be also aware, that the logical expressions sometimes are written as X_0 , X_1 , ... and sometimes with other letters, like a , b , ...

math representation

Nr	Math Term / Formula	Description
1	Closure	The operators \land and \lor map elements from $B = \{a, b, \dots, n\}$ to B .
	$B \land B \rightarrow B$	
	$B \lor B \rightarrow B$	
	Duality	If A is a statement of boolean algebra, so is A^* . A^* is obtained by exchanging \land with \lor and vice versa.
3	Neutral Element	There exist a neutral element to the operators \land and \lor . Applying the operator to a and the neutral element results in a .
	$a \land 1 = a$	
4	$a \lor 0 = a$	There exist a complementary element to the operators \land and \lor . The negation of a is for both operators the complementary element.
	Complementary Element	
5	$a \land \bar{a} = 0$	Applying the operators \land and \lor to a similar input a results in a .
	$a \lor \bar{a} = 1$	
6	Idempotence	Inputs a and b are interchangeable.
	$a \land a = a$	
	$a \lor a = a$	
	Commutative Law	
	$a \land b = b \land a$	
	$a \lor b = b \lor a$	

Nr	Math Term / Formula	Description
7	Associative Law	For the same operator bracketing can be moved. associative means "to unite" or "to connect"
	$a \wedge (b \wedge c) = (a \wedge b) \wedge c$	
	$a \vee (b \vee c) = (a \vee b) \vee c$	
8	Distributive Law	The bracketing is similar like for multiplication: $a \cdot (b + c) = (a \cdot b) + (a \cdot c)$. However this is true for both boolean operators!
	$a \wedge (b \vee c) = (a \wedge b) \vee (a \wedge c)$	
	$a \vee (b \wedge c) = (a \vee b) \wedge (a \vee c)$	
9	Law of Absorption	In bracketed formulas similar expressions can "absorb" each other. This law can be derived from the laws (8), (5), (7)
	$a \wedge (a \vee b) = a$	
	$a \wedge (\bar{a} \vee b) = a \wedge b$	
	$a \vee (a \wedge b) = a$	
10	DeMorgan's Rule	\wedge can be written as \vee , BUT one has to negate the inputs and outputs
	$\overline{a \wedge b} = \overline{\overline{\bar{a}} \vee \bar{b}}$	
	$\bar{a} \vee \bar{b} = \overline{\bar{\bar{a}} \wedge \bar{\bar{b}}}$	
	$\overline{a \vee b} = \overline{\overline{\bar{a}} \wedge \bar{b}}$	
	$\bar{a} \wedge \bar{b} = \overline{\bar{\bar{a}} \vee \bar{\bar{b}}}$	

algebraic representation

Nr	Math Term / Formula	Description
1	Closure	The operators \cdot and $+$ map elements from $B = \{a, b, \dots, n\}$ to B .
	$B \cdot B \rightarrow B$	
	$B + B \rightarrow B$	
2	Duality	If A is a statement of boolean algebra, so is A^* . A^* is obtained by exchanging \cdot with $+$ and vice versa.
3	Neutral Element	There exist a neutral element to the operators \cdot and $+$. Applying the operator to a and the neutral element results in a .
	$a \cdot 1 = a$	
	$a + 0 = a$	
4	Complementary Element	There exist a complementary element to the operators \cdot and $+$. The negation of a is for both operators the complementary element.
	$a \cdot \bar{a} = 0$	
	$a + \bar{a} = 1$	
5	Idempotence	Applying the operators \cdot and $+$ to a similar input a results in a .
	$a \cdot a = a$	
	$a + a = a$	
6	Commutative Law	Inputs a and b are interchangeable.
	$a \cdot b = b \cdot a$	
	$a + b = b + a$	

Nr	Math Term / Formula	Description
7	Associative Law	For the same operator bracketing can be moved. associative means "to unite" or "to connect"
	$a \cdot (b \cdot c) = (a \cdot b) \cdot c$	
	$a + (b + c) = (a + b) + c$	
8	Distributive Law	The bracketing is similiar like for multiplication: $a \cdot (b + c) = (a \cdot b) + (a \cdot c)$. However this is true for both boolean operators!
	$a \cdot (b + c) = (a \cdot b) + (a \cdot c)$	
	$a + (b \cdot c) = (a + b) \cdot (a + c)$	
9	Law of Absorbtion	In bracketed formulas similar expressions can "absorb" each other. This law can be driven from the laws (8), (5), (7)
	$a \cdot (a + b) = a$	
	$a \cdot (\bar{a} + b) = a \cdot b$	
	$a + (a \cdot b) = a$ $a + (\bar{a} \cdot b) = a + b$	
10	DeMorgan's Rule	\cdot can be written as $+$, BUT one has to negate the inputs and outputs
	$\overline{a \cdot b} = \overline{\overline{\bar{a}} + \bar{b}}$	
	$\bar{a} + \bar{b} = \overline{\bar{\bar{a}} \cdot \bar{\bar{b}}}$	
	$\overline{\overline{\bar{a} \cdot \bar{b}}} = \overline{a \cdot b}$	
	$\overline{a + b} = \overline{\overline{\bar{a}} \cdot \bar{\bar{b}}}$ $\bar{a} \cdot \bar{b} = \overline{\bar{\bar{a}} + \bar{\bar{b}}}$ $\bar{a} \cdot \bar{b} = \overline{\bar{\bar{a}} + \bar{\bar{b}}}$	

The last 3 laws are probable a kind of unintuitive. Therefore, these are shown in other representations. in the following

1.5.2 Dive into Distributive Law

The distributive law can be shown on a simple example of daily life.
When one says

"I'm happy with fries AND (a water OR a coke)"

he will be happy with

(fries AND a water) OR (fries AND a coke)

Be aware, that the is no exclusiveness here. The person would also be happy with fries AND a water AND a coke!

The gate representation is shown in [figure 32](#). At the first glimpse, the output Y of the upper circuit and the lower circuit look similar (they are indeed the same). Also the truth tables for the first gate (Y , Y' , Y'') and a larger truth table for all results is given.

But the conversion of the upper one to the lower one is not intuitive here. That is why the multiple representations and remembering the rules for boolean algebra is very important. Translating from one representation into another one helps to use other tools in order to simplify systems!

Fig. 32: Distributive Law

1.5.3 Dive into Law of Absorbion

We will also try to transfer the law of absorbion to a example of daily life.

When one says

"I'm happy with fries OR (fries AND a coke)"

he will be happy with

fries..

No matter whether there is coke with it.

The absorbion of the inverse ($a + (\bar{a} \cdot b) = a + b$) is also possible:

When one says

"I'm happy with fries OR (no fries AND a coke)"

he will be happy with

fries OR a coke

When he only gets fries the first part is true. When he only gets coke, the secont part is true. When he gets both, he of course gets fries and therefore the firt part is true..

The gate represenation is shown in [figure 33](#). When ignoring the blinking High and Low of the lines, also here the similarity of the upper and lower circuits may be not really intuitive.

Fig. 33: Law of Absorbion

1.5.4 Dive into DeMorgan's Rule

At last, let's have a look onto DeMorgan's rule. The following instance shows it in daily life.

When one says

"I don't like fries AND i don't like coke"

he will be unhappy when he gets either fries, or coke, or (fries and coke).

The gate represenation is shown in [figure 34](#). All four circuits show the same behaviour.

On the left the NOT gate is explicitly shown. On the right the NOT gates are shrinked down to the circles either on the input or on the output.

Fig. 34: DeMorgan's Rule

The important thing about DeMorgan's rules is: any expression stays the same, when

- all parts of the expression are inverted plus
- any AND is substituted with OR plus
- any OR is substituted with AND

Important is, that also the most upper expression also have to be inverted.

1.5.5 Example of a logic simplification

1.6 Examples of gate circuits

1.6.1 Logic gates with multiple inputs

Based on the associative law, when purely AND gates or purely OR gates are stacked the inputs are interchangeable.

Therefore, this stacking can be substituted with a gate symbol with multiple input. The two AND-gates shown in [figure 35](#) can be substituted with a single one.

The essence auf the AND gate is: An AND gate - no matter how much inputs it has - will only output high, when all inputs are high.

Fig. 35: AND gate with multiple inputs

Exercise 1.6.1. Other gates with multiple inputs

1. What is the essence of an OR gate? what will the truth table of an OR gate with 3 inputs look like?
2. What is the essence of an XOR gate? what will the truth table of an XOR gate with 3 inputs look like? (keep in mind, that this question might have multiple answers for XOR)

1.6.2 Switchable inverter

Sometimes it is important switch between inverting and not inverting an output. This can be done with the XOR gate. When the EN in [figure 36](#) is active, the input X will be inverted.

Fig. 36: switchable inverter

One application for a switchable inverter would be an monochrome display, where every pixel can be set by one bit. When the display (or a small part like the cursor symbol) has to be inverted it would be great to do so with a simple gate. This can be seen in [this more complex example](#), where the display smiley can be inverted via the XOR gate during data transmission. The other logic component in this example will be explained in the following (sub)chapters.

Another usage is the inversion of binary numbers in the arithmetic logical unit of the processor.

1.6.3 Data valve

To deactivate a data flow a simple AND gate can be used. This is also useful for channelize data in multiple directions.

In the upper part of [figure 37](#) a single data valve is shown. Only when $EN=1$, then the value of the data input D will set as the output Y .

The lower part of [figure 37](#) shows the combination of two data valves. In this circuit depending on EN the output of the the data input DX will either be $Y0$ or $Y1$. This is also visible in the truth table. The truth table can be shortened which is also shown.

Fig. 37: Data valve(s)

1.6.4 Multiplexer and Demultiplexer

In the linked 'display example' in 1.6.2 there were a Multiplexer (MUX) and a Demultiplexer (DEMUX) visible.

A **multiplexer** is a electronic switcher, which has several data inputs $D0$, $D1$... and one data output Y . Additionally to the data input there are also state inputs $S0$, $S1$, The state inputs address which of the data input is routed to the data output. An example is given in [figure 38](#). When $S0 = 0$ and $S1 = 0$ the zeroth data input $D0$ is the output, for $S0 = 1$ and $S1 = 0$ the first data input $D1$, for $S0 = 0$ and $S1 = 1$ the second. The 'inner live' of the multiplexer will be shown in the chapter 3.

A **demultiplexer** is the counterpart to the multiplexer: It has one data input D and several data outputs $Y0$, $Y1$, Again there are also state inputs $S0$, $S1$ Here, the state inputs address to which data output the single data input is routed. also this is shown in [figure 38](#).

Fig. 38: Multiplexer and Demultiplexer

With the background given in subchapter 1.6.3 the demultiplexer can be derived. The example in the subchapter 1.6.3 an input were forwarded to 2 outputs. We will now have a look onto a demultiplexer with 4 outputs. For this instead of an AND gate with two inputs an AND gate with three inputs are used. The top-most input is the data input D for all gates. The other two inputs address which of the AND gate will route the data input. When one has a detailed look onto the addressing inputs, one can see in any time that only one AND gate has both lower inputs high.

Fig. 37: Demultiplexer exposed

related Links

- [Solver for Boolean functions](#): The solver specifies with which axioms Boolean equations can be

- simplified.
- [Wolfram Alpha](#) shows the different representations for boolean statements
 - A nice overview of core ideas for [calculating with electricity](#) has been compiled by Gymnasium Kirchenfeld (CH, in German)
 - Explanation of [CMOS](#) in the english Wikipedia
 - Wiki page on [integrated circuits](#)
 - [Silicon Zoo](#): Here you can see the practical implementation of logic gates in silicon.
 - [Die photos and analysis ICs](#)

Applications

- [Ethereum](#): With this cryptocurrency, calculations on the blockchain are possible. Here, the basic logical functions are the most convenient - so a program should be feasible with as few boolean operators as possible
- [Example in C](#) for using of boolean algebra: by clicking on the Fork this button, the code can be changed.

Exercises

Exercise 1.6.2. truth tables

Determine the value of the output Y for the following logic using truth tables!

Fig. 40: logic circuits

Exercise 1.6.3. timing diagram

Complete the timing diagram for input signals X_0 and X_1 :

Fig. 41: Timing Diagram



Solution

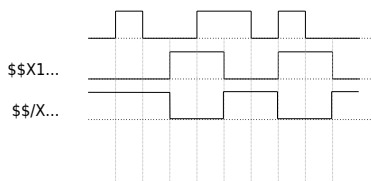

Exercise 1.6.4. NAND-based gates

Realize the logic functions of AND, OR, NOT, NAND, XOR and XNOR exclusively with NAND gates.

Exercise 1.6.5. NOR-based gates

Realize the logic functions of AND, OR, NOT, NAND, XOR and XNOR exclusively with NOR gates.

Exercise 1.6.6. simplification of logic expressions

Simplify the following expressions with boolean algebra. Write down the rule for each step!

1. $Y = (\overline{X_0} \overline{X_1} \overline{X_2}) + (X_0 X_1 \overline{X_2}) + (\overline{X_0} X_1 X_2) + (X_0 X_1 X_2)$
2. $Y = (X_0 X_1 X_2 X_3) + (X_0 X_1 X_2 \overline{X_3}) + (X_0 X_1 \overline{X_2} X_3) + (\overline{X_0} X_1 X_2 X_3)$
3. $Y = (X_0 X_1 X_2 X_3) + (\overline{X_0} X_1 X_2 X_3) + (\overline{X_0} X_1 \overline{X_2} X_3)$
4. $Y = (\overline{X_0} X_1 \overline{X_2} X_3) + (\overline{X_0} X_1 X_2 X_3) + (X_0 \overline{X_1} \overline{X_2} X_3) + (\overline{X_0} \overline{X_1} \overline{X_2} X_3)$
5. $Y = (\overline{X_0} \overline{X_1} \overline{X_2} X_3) + (\overline{X_0} X_1 \overline{X_2} X_3) + (\overline{X_0} \overline{X_1} X_2 X_3) + (\overline{X_0} X_1 X_2 X_3)$

Exercise 1.6.7. only using NAND

Rewrite the following expressions using only NAND, NOT and AND. Check the result for equality using truth tables.

1. $Y = X_0 + X_1 \overline{X_2}$

2. $Y = (X_0 \cdot X_1)$
3. $Y = X_0 \cdot X_1 + X_2$
4. $Y = X_0 \cdot X_1$
5. $Y = ((X_0 + X_1) + X_0 \cdot X_1)$
6. $Y = (X_0 + X_1 + X_2) + (X_0 + X_1 + X_2)$

Exercise 1.6.8. step by step example for logic simplification using boolean rules

Hints for the clip:

- The ladder logic is not necessary for our course.
- Example 1 ist quiet exhausting including a recap of the boolean rules \rightarrow you can skip this example
- Example 2 starts at 17:17
- Example 3 starts at 21:00
- Example 4 starts at 28:27
- Example 5-8 start at 32:33

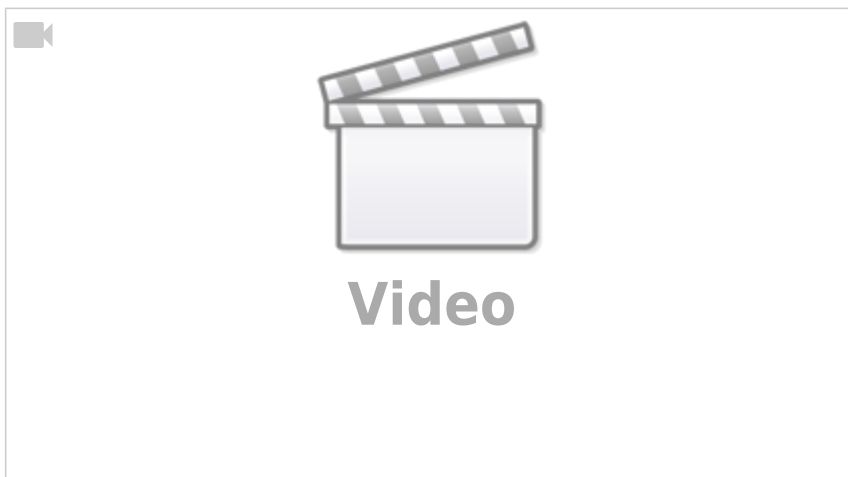

Exercise 1.6.9. XOR in Cryptography

In the following EXCEL file an example of symmetric encryption can be found:

[xor_in_cryptography.xlsx](#)

- Try to understand [XOR_cipher](#) with this example.
- Which advantages and disadvantages does symmetric encryption have?

References

1. [figure ##: Sbp@Wikimedia, CC BY-SA 4.0](#)
2. [figure 3: TravisGoodspeed@FlickrCC BY 2.0](#)
3. [figure 4: ZeptoBars@Wikimedia,CC BY 3.0](#)
4. [figure 2, figure ##: SiliconZoo.org, Lizenz unbekannt](#)
5. [figure ##: David Carron@Wikimedia,public domain](#)

1)

In detail it is a bit more complicated, since USB is not using the voltage levels but the edges to

encode the bits. Details [here](#)

From:

<https://wiki.mexle.org/> - **MEXLE Wiki**

Permanent link:

https://wiki.mexle.org/introduction_to_digital_systems/boolean_algebra?rev=1666159504

Last update: **2022/10/19 08:05**

